



By appointment to The Royal Danish Court

morsø

Installation and Operating Instructions 6170

For use in North America



Read this entire manual before you install and use your new room heater. If this room heater is not properly installed, a house fire may result. To reduce the risk of fire, follow the installation instructions. Failure to follow instructions may result in property damage, bodily injury, or even death.

Contact local building officials about restrictions and installation/inspection-requirements in your area.

Save these instructions

**MORSØ JERNSTØBERI A/S · DK-7900 NYKØBING MORS
E-Mail: stoves@morsoe.com · Website: www.morsoe.com**

**Distributed by: MORSO US LLC
1011 Highway 52 West - Portland TN - 37148 - USA**

We congratulate you on your choice of a Morsø stove. Morsø has been producing some of the world's best stoves since 1853. If you follow this installation- and operating instruction carefully, we can assure you many years of warmth and pleasure.

Optional Accessories

A wide range of accessories (such as handling gloves, fireside tools, glass cleaner and heatproof paint) are available for use with your Morsø stove. They help with day-to-day running and maintenance. Contact your Morsø dealer for more information.

The Morsø 6170 meets the U.S. Environmental Protection Agency's emission limits for wood heaters sold on or after July 1, 1990.



The Morsø 6170 have been tested by OMNI-Test Laboratories, Inc. The test standards are ANSI/UL-1482 for the United States and ULC S627 for Canada.

The stove is listed for burning wood only. Do not burn other fuels.

Under specific test conditions this heater has been shown to deliver heat at rates ranging from 11,117 to 21,992 Btu's.

Cast iron

Cast iron is a live material. There are no two ovens that are identical. This is partly due to the tolerances of the casting process, partly because the ovens are a work of craftsmanship.

CONTENTS:

1.0	Installation of your Morsø stove	4
1.1	Checking loose parts in the stove	4
1.2	The chimney / flue system	5
1.3	Flue Connection	6
1.4	Connection to existing chimney	6
1.5	Positioning the stove	8
2.0	Operation	12
2.1	Before you start firing	12
2.2	Lighting and loading intervals	13
3.0	Maintenance	16
3.1	Exterior maintenance	16
3.2	Internal maintenance	16
3.3	Cleaning the stove and the flue	18
3.4	Leaving the stove for extended periods	21
3.5	Parts diagram	22
3.6	Parts list	23

1.0 Installation of your Morsø stove

Installation of woodburning stoves must be safe and legal.

Consult with a structural engineer for the installation.

The stove must be installed on a non-combustible wall.

If your Morsø stove is not installed correctly, it may cause a house fire. To reduce the risk of fire, the installation instructions must be followed carefully. Contact the local building officials about restrictions and installation inspection in your area.

Before you start installing your stove, make sure that:

- The stove and chimney connection are placed far enough from combustible materials to meet all clearance requirements.
- The floor protection must be adequate and must be made correctly according to 'the requirements.

All necessary approvals are needed from the local building officials.

The data plate, which is located on the back of the stove, provides information regarding safety testing information, name of certified testing laboratory, and installation requirements.

Installation requirements vary in different districts, and the local building officials have the final authorization to approve your installation. You should discuss the installation with them before beginning. Please ask your dealer for further information.

Do not connect to any air distribution duct or system.

Important: If the installation instructions are not followed carefully, it may cause dangerous situations like chimney - and house fires. Follow the instructions carefully and do not deviate from them as it may cause injuries to people or property.

1.1 Checking loose parts in the stove

After unpacking, check that the fire bricks are firmly in position and have not shifted in transit. Check also that the air control works freely.

Before starting the initial fire, make sure that the baffles is placed correctly.

Standard Accessories

A Morsø glove and ceramic flue connection gasket are standard accessories that usually can be found in the ashpan or firebox area.

1.2 The chimney / flue system

Note that the flue system must be independently secured and must not rely on the stove for support.

The stove must not be connected to a chimney flue serving any other appliance. (Several flues may run up a single chimney stack; use one flueway per appliance).

Use a residential type masonry or listed type HT factory-built chimney.

High Temperature (H.T.) Chimney Standard UL-103-1985 (2100° F.) or a code-approved masonry chimney with flue liner for the USA, and High Temperature (650°C) Standard ULC S-629 for Canada.

The internal dimensions of the chimney connector and chimney must not be less than 6 inches diameter (or equivalent cross section), and should not be significantly larger than this. Too large a section will tend to allow the flue gases to cool excessively, causing sluggishness or unpredictability in the stove's performance.

We recommend the length of the chimney system should be at least 16 feet (not required) above the stove in normal domestic situations, measured from the flue collar to the top of the chimney.

Local conditions like for example - roof constructions, large trees nearby and high altitude, may influence the chimney draft and height. Therefore, contact the local professional chimney sweep or your Morsø dealer.

Typical Factory-Built or Masonry Chimney Installations

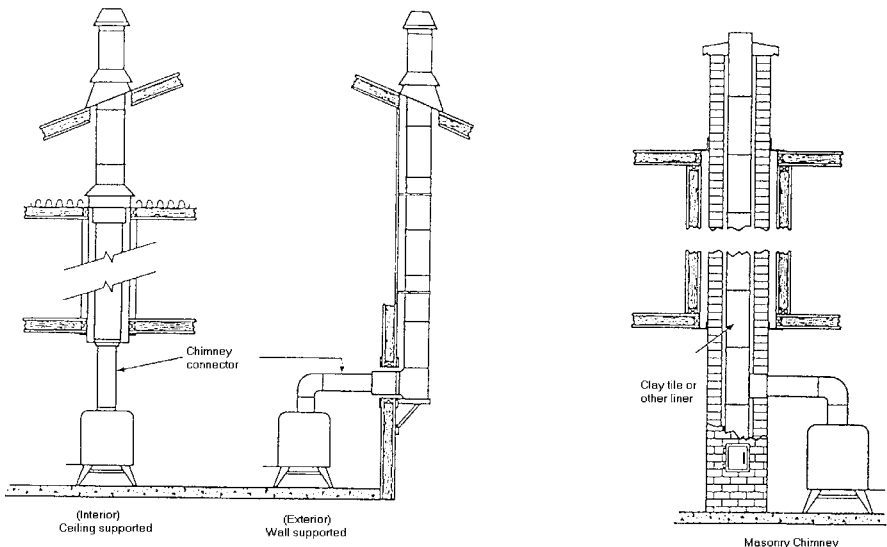

1.3 Flue Connection

The stove is supplied from the factory with a round blanking plate blocking off the top and rear flue exit (behind the rear shield plate). A flue collar are placed in the firebox area.

Use a 24 MSG black or blue chimney connector or listed double wall chimney connector. Refer to local codes and the chimney manufacturer's instructions for precautions required for passing a chimney through a combustible wall or ceiling. Remember to secure the chimney connector with a minimum of three screws to the product and to each adjoining section.

The collar can be fitted to the rear outlet. Simply knock out the round panel on the rear heat shield plate to reveal the cast iron plate. Untwist the blanking plate and the flue collar and swap their positions. Re-secure by pushing down and tighten the enclosed screws.

Position the stove and connect to the flue system.

Wear gloves and protective eyewear when drilling, cutting or joining sections of chimney connector

1.4 Connection to the existing chimney

A chimney connector is the double-wall or single-wall pipe that connects the stove to the chimney. The chimney itself is the masonry or prefabricated structure that encloses the flue. Chimney connectors are used only to connect the stove to the chimney.

Double-wall connectors must be tested and listed for use with solid-fuel burning appliances. Single-wall connectors should be made of 24 gauge or heavier gauge steel. Do not use galvanized connector; it cannot withstand the high-temperatures that smoke and exhaust gases can reach, and may release toxic fumes under high heat. The connector must be 6 inches (150 mm) in diameter.

If possible, do not pass the chimney connector through a combustible wall or ceiling. If passage through a combustible wall is unavoidable, refer to the sections on Wall Pass-Throughs. Do not pass the connector through an attic, a closet or similar concealed space when installing the chimney connectors.

It is important to keep the flue gases moving smoothly in the right direction. Do not vent into a large void at this location; rather form one continuous section all the way up. Use mild bends (e.g. 45° vs. 90°) rather than sharp angles where a change of direction is required. All parts of the venting must be accessible for cleaning purposes.

In horizontal runs of chimney, maintain a distance of 18 inches from the ceiling. Keep it as short and direct as possible, with no more than two 90 degree turns. Slope horizontal runs of connector upward 1/4 inch per foot (20 mm per metre) going from the stove toward the chimney. The recommended maximum length of a horizontal run is 3 feet (1 metre), and the total length should be no longer than 8 feet (2.5 metres).

Information on assembling and installing connectors is provided by the manufacturer's instructions exactly as you assemble the connector and attach it to the stove and chimney.

Be sure the installed stove and chimney connector are correct distances from near by combustible materials. See the clearance paragraph page 8.

Where passage through a wall or partition of combustible construction is desired, the installation shall conform to CAN/CSA-B365.

Chimney Connector Systems and Clearances from Combustible Walls for Residential Heating Appliances

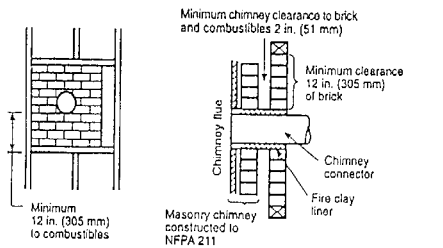

- A Minimum 3.5-in thick brick masonry all framed into combustible wall with a minimum of 12-in brick separation from clay liner to combustibles. The fireclay liner shall run from outer surface of brick wall to, but not beyond, the inner surface of chimney flue liner and shall be firmly cemented in place.

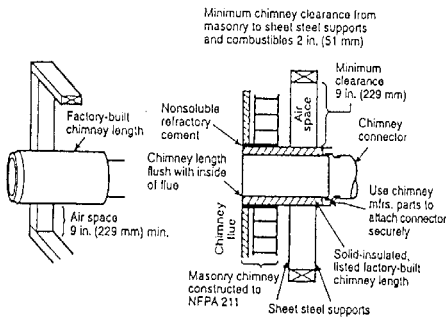

- B Solid-insulated, listed factory-built chimney length of the same inside diameter as the chimney connector and having 1-in. or more of insulation with a minimum 9-in. air space between the outer wall of the chimney length and combustibles.

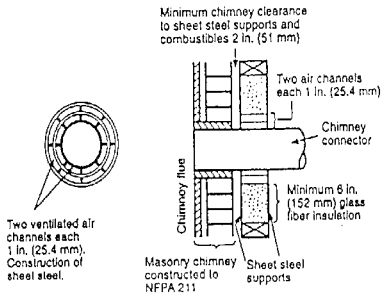

- C Sheet steel chimney connector, minimum 24 gauge in thickness, with a ventilated thimble, minimum 24 gauge in thickness, having two 1-in. air channels, separated from combustibles by a minimum of 6-in. of glass fiber insulation. Opening shall be covered, and thimble supported with a sheet steel support, minimum 24 gauge in thickness.

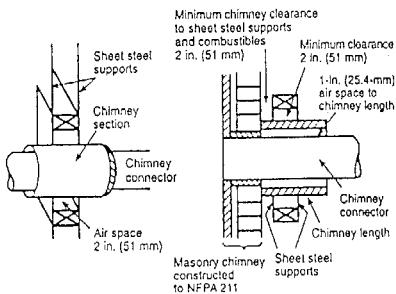

- D Solid insulated, listed factory-built chimney length with an inside diameter 2-in. larger than the chimney connector and having 1-in. or more of insulation, serving as a pass-through for a single wall sheet steel chimney connector of minimum 24 gauge thickness, with a minimum 2-in. air space between the outer wall of chimney section and combustibles. Minimum length of chimney section shall be 12-in. chimney section spaced 1-in. away from connector using sheet steel support plates on both ends of chimney section. Opening shall be covered, and chimney section supported on both sides with sheet steel supports securely fastened to wall surfaces of minimum 24 gauge thickness. Fasteners used to secure chimney section shall not penetrate chimney flue liner.

1.5 Positioning the stove

The stove must be installed on a non-combustible wall.

The wall-mounting fixture is provided with four holes for mounting expansion bolts in the wall. The bolts must be sized to secure that the wall and the materials it is made from are capable of supporting the stove. If in doubt, contact an expert. The weight of the empty stove is 105 kg (232 lbs.). The wall-mounting fixture may be used as drilling template.

Mount the wall-mounting fixture on the wall. If the flue exit is wanted to the rear, build a wall bushing correctly into the wall (see illustration).

Lift the wood stove in place so that it rests on the bottom part of the wall-mounting fixture, and secure it again to the fixture by means of the screws included.

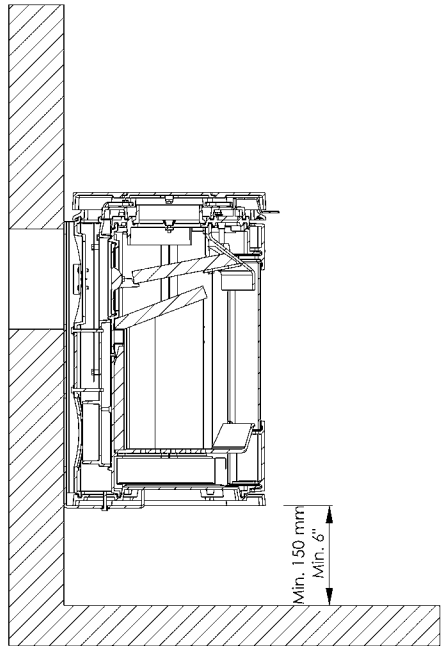

Distance to walls and lintel

When the stove is positioned near combustible materials, observe all current local and national building regulations with regards to clearances. Whatever regulations apply to your area, do not in any case install the stove within 8 inches of combustible materials around the sides or 16 inches above the top of the stove (fireplace installations require greater clearances above the stove - see below in the clearance chart). These distances may need to be increased if the materials are sensitive to heat. Note also that wall paper and other decorative materials may become detached with the effects of heat and care should be taken to ensure that they do not fall towards the stove in such an event.

If using rear exit, the floor protection must extend beneath the chimney connector and 2-in beyond each side.

CLEARANCE REQUIREMENTS:	STANDARD RESIDENTIAL INSTALLATION (SINGLEWALL CONNECTOR)	
	USA	Canada
A. SIDEWALL TO UNIT	10" (254 mm)	10" (254 mm)
B. BACKWALL TO UNIT	3" (76 mm)	3" (76 mm)
C. SIDEWALL TO CONNECTOR	15,5" (394 mm)	15,5" (394 mm)
D. BACKWALL TO CONNECTOR	7,5" (190 mm)	7,5" (190 mm)
E. UNIT TO CEILING	54.5" (1384 mm)	54.5" (1384 mm)
F. FLOOR TO CEILING	84" (2134 mm)	84" (2134 mm)
G. CORNERWALL TO UNIT	-	-
H. CORNERWALL TO CONNECTOR	-	-

MINIMUM CLEARANCES
TO COMBUSTIBLES:

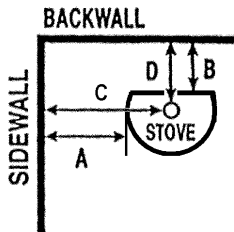

CLEARANCE REQUIREMENTS:	STANDARD RESIDENTIAL INSTALLATION (DOUBLEWALL CONNECTOR):	
	USA	Canada
A. SIDEWALL TO UNIT	10" (254 mm)	10" (254 mm)
B. BACKWALL TO UNIT	2" (51 mm)	2" (51 mm)
C. SIDEWALL TO CONNECTOR	15,5" (394 mm)	15,5" (394 mm)
D. BACKWALL TO CONNECTOR	6,5" (165 mm)	6,5" (165 mm)
E. UNIT TO CEILING	54.5" (1384 mm)	54.5" (1384 mm)
F. FLOOR TO CEILING	84" (2134 mm)	84" (2134 mm)
G. CORNERWALL TO UNIT	-	-
H. CORNERWALL TO CONNECTOR	-	-

CLEARANCE REQUIREMENTS:	STANDARD RESIDENTIAL INSTALLATION REAR VENT OUT BACK WALL SINGLEWALL CONNECTOR:	
	USA	Canada
A. SIDEWALL TO UNIT	10" (254 mm)	10" (254 mm)
B. BACKWALL TO UNIT	6,5" (165 mm)	6,5" (165 mm)
C. SIDEWALL TO CONNECTOR	15,5" (394 mm)	15,5" (394 mm)
D. BACKWALL TO CONNECTOR	-	-
E. UNIT TO CEILING	-	-
F. FLOOR TO CEILING	-	-
G. CORNERWALL TO UNIT	-	-
H. CORNERWALL TO CONNECTOR	-	-

NON-COMBUSTIBLE FLOOR PROTECTOR

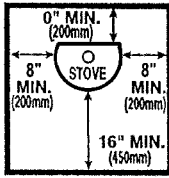

FLOOR PROTECTOR MUST BE NON-COMBUSTIBLE MATERIAL. IT MUST EXTEND BENEATH HEATER, AND TO THE FRONT/SIDES/REAR AS INDICATED.

ALCOVE INSTALLATION

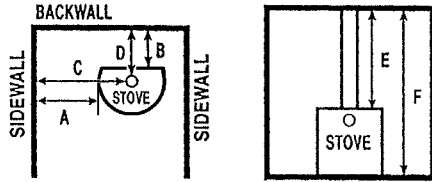

*Maximum alcove depth must be no more than 32" (813mm)

CLEARANCES IN () IN MM FOR CANADA FOR NON-COMBUSTIBLE FLOOR PROTECTOR

CLEARANCE REQUIREMENTS:	ALCOVE INSTALLATION WITH (DOUBLE WALL CONNECTOR):
A. SIDEWALL TO UNIT	12" (305 mm)
B. BACKWALL TO UNIT	3" (76 mm)
C. SIDEWALL TO CONNECTOR	17" (432 mm)
D. BACKWALL TO CONNECTOR	7,5" (190 mm)
E. UNIT TO CEILING	24,5" (622 mm)
F. FLOOR TO CEILING	54" (1372 mm)
G. CORNERWALL TO UNIT	-
H. CORNERWALL TO CONNECTOR	-

Distance to furniture

The recommended minimum distance from stove to furniture is 30 inches. Note that some furniture is more easily affected by heat and may need to be moved to a greater distance. This is your responsibility.

In addition other combustible materials, away from the stove. In general, a distance of 30 inches must be maintained between the stove and moveable combustible item such as drying clothes, newspapers, firewood etc.

WARNING:

**NEVER DRAW COMBUSTION AIR FROM A WALL, FLOOR OR CEILING CAVITY OR FROM ANY ENCLOSED SPACE SUCH AS AN ATTIC OR GARAGE.
DO NOT INSTALL IN SLEEPING ROOM.**

Note:**Acid Protection**

If acid-washing the masonry around the stove, protect the stove surface with an acid-proof cover

Fresh Air Inlet

Unless there is deemed to be sufficient ambient leakage of air into the room via doorways, windows and the like, a dedicated fresh air inlet will be needed. This inlet should have 2 square inches (1250 square mm) of free air space. This is particularly important where the room is well sealed, or where an extractor hood or ventilation system disturbs the natural air pressure. Such an inlet should not be on a wall that is usually subject to negative pressure from normal wind pattern. Avoid placing the inlet directly across the room from the stove, thus causing a cold air draft.

2.0 Operation

2.1 Before you start firing

For Use with Solid Wood Fuel Only. Do Not Overfire, If Heater or Chimney Connector Glows You Are Overfiring. Inspect and Clean Chimney Frequently. Under Certain Conditions of use creosote buildup may occur rapidly. Because of risk of smoke and flame spillage, operate only with door fully closed.

Caution:

Hot while in operation. Keep children, clothing and furniture away. Contact may cause skin burns.

Do not use chemicals or fluids to start the fire.

Do not burn garbage or flammable fluids.

Do not use gasoline, gasoline-type lantern fuel, kerosene, charcoal lighter or fluid or similar liquids to start or freshen up a fire in this heater. Keep all such liquids away from the heater while it is in use.

Choosing your fuel

Cut the wood to a length of max 12 inches (30 cm) and approx. 3 to 3.5 inches (7-8 cm) in section. If you can weigh your wood, aim for around 2 lbs. For correct combustion and heat output, wood fuel should contain no more than 20% moisture; this can easily be checked by using the Morsø Moisture Meter (part # 62929900)

To naturally season wood fuel, stack and store it under cover in an airy location where fresh air can move through each piece. Some soft woods may take as little as one good summer to season whereas harder woods such as oak, maple, and elm may require seasoning up to 18 months. Avoid overly dry wood that is gray in color as under certain conditions it can cause performance problems, such as back-puffing and sluggishness. Well seasoned wood will be light to hold and will show signs of cracking from the center-out in the ends. If your wood spits or sizzles when burnt, and your stove's door glass persistently mists up, your wood is not properly seasoned. Never use drift wood (from the sea), whose salt content may cause corrosion, nor construction wood that may have been impregnated with chemicals.

Caution: Do not place fuel within the installation clearances for the stove or within the space required for loading fuel and ash removal.

Starting the First Fire

The initial fire should be small, so that the stove paint can cure and the main plates of the stove can settle into position. Some fumes will be given off by the paint. Ventilate the room during this phase.

The setting of the air control, lighting techniques and loading intervals will depend on chimney draft, the fuel used, the heat required and so on. Some basic techniques are outlined below.

In principle

Your stove should be with Primary and Secondary air and Pilot air inlets.

Primary Air is controlled using the lever situated over the door. Moving the control lever to right position will open the air inlet and will allow a supply of preheated air to enter the firebox via the 'airwash' system situated inside the stove and above the glass.

The secondary air is injected into the flue gases above the fire resulting in a cleaner, more efficient combustion process. The supply of secondary air and Pilot air is fixed open and is not adjustable.

For extra safety, your stove should be with a removable handle.

2.2 Lighting and loading intervals

When first lighting the stove, a large volume of air is needed. When the stove is cold, you should leave the door open an inch or two for the first few minutes and open the primary air supply completely. While the door is open, do not leave the stove unattended.

To form a reasonable bed of ash on the floor of the stove, you should use 2-4 pounds of dry kindling at the initial lighting. If possible, maintain a 1-1.5 inch (2-3 cm) layer of ash on the floor of the combustion chamber for added insulation.

Step-by-step procedure

1. The air supply must be fully open.
2. For lighting the fire use 2-3 pounds of dry kindling wood.
3. Light the fire. An ember bed will quickly be formed by lighting with firestarters, Morsø kindling bags or 7-10 pieces of twisted paper under the dry kindling wood.



4. After lighting, partially close the door, leaving it open an inch or two to allow in plenty of combustion air.



5. When the chimney is warm after about 5-10 minutes, the door should be closed. A suitable layer of ember will be formed after about 15-20 minutes.



6. When ready to reload, use a poker to spread the embers across the firebox floor, bringing plenty towards the front of the stove.



7. Lay three pieces of wood onto the embers. Leave half an inch or more between each piece.
Max. fuelload 4.0 pounds/h.



8. Close the door. Leave the primary air supply fully open.
If it does not light, leave the door slightly ajar to allow the necessary amount of air in to ignite the wood.
Close the door again once the wood has kindled.



9. After a few minutes, adjust the primary air supply to suit your heating requirements. Make sure that there is always enough air to sustain clear, enduring flames when you reduce the amount of combustion air, and afterwards.



10. For refueling, add a layer of wood while there are still plenty of live embers, repeat steps 6-9.



Do not for any reason attempt to increase the firing of your heater by altering the air control adjustment range outlined in these directions.

Warning: Fireplace stoves must never be left unattended with the door open.

If the door is left partly open, gas and flame may be drawn out of the fireplace stove opening, creating risks from both fire and smoke. We recommend that you fit a smoke detector in the room where the stove is installed.

DO NOT OVERFIRE THIS HEATER. Overfiring may cause a house fire, or can result in permanent damage to the stove. If any part of the stove glows, you are overfiring.

The maximum recommended weight of wood fuel per load is 2.0 kg/h/4.0lbs (approx 3 split logs).

Under normal firing, the average flue temperature in the stove pipe, measured 20 cm above the stove, is approx. 300° C (550°F). The maximum flue temperature in the stove pipe must not exceed 450° C (750°F). If the flue temperature exceeds 450°C (750°F), it is considered as over firing and may cause premature wear and tear of the stove.

To help gauge the correct running temperature of your stove, we recommend you use the Morsø Flue Gas Thermometer (part # 62901200). The Flue Gas Thermometer magnetically attaches onto the stove pipe approx 20 cm (8") above the stove's top plate and measures the surface temperature of the stove pipe. Please see your authorized Morsø Dealer for availability.

Draft conditions

If smoke or fumes come out of your stove when lightning up and reloading, or if the fire simply will not respond, a poor draft is almost certainly to blame. (In a very few cases, there may be insufficient fresh air getting into the room - see installation advice above). Take advice from your stove supplier on how best to upgrade your flue system to improve draft.

Rules of woodburning

If you want less heat, put fewer logs on the stove and reduce the amount of air. It is still important to maintain a good layer of embers.

Less heat - less wood - less air

Greater heat - more wood - more air

Soot deposits will settle on the glass if the stove is run too slowly or if your wood is not well seasoned.

We would strongly recommend that you do not leave your stove alit at night. It harms the environment, and constitutes very poor use of the wood, as the gases in the wood do not ignite at the low temperature, but settle as soot (unburned gases) in the chimney and stove instead.

3.0 MAINTENANCE

When performing maintenance on your stove, always protect yourself, using safety goggles and gloves.

3.1 Exterior Maintenance

The stove surface is painted with heat-resistant Senotherm paint. It is best kept clean by vacuuming with a soft brush attachment or by wiping with a lint-free cloth.

Over a period of time, the painted surface may become slightly grey. A can of Morsø touch-up spray paint should be available from your stove supplier. This can be applied - in accordance with the instructions - in just a few minutes. When first firing after touching up, the stove will give off a slight smell as the paint cures. Make sure to ventilate the room well during this phase.

3.2 Internal maintenance

Glass

If the stove is generally run at the correct temperatures, there should be little or no dirt on the glass. If dirt does settle during lighting, most will burn off as temperatures increase. For heavier deposits that will not burn off, use morsø glass cleaner, applied when the glass is cold, in accordance with the instructions. Never use abrasive cleaners on the glass surface.

Reasons for dirty glass

- **Fuel too wet**
- **Logs too large or not split**
- **Combustion temperatures too low**

**Replace broken glass immediately.
Do not operate your stove if the glass in the door is damaged.**

If you need to replace the glass, it should be replaced with the high temperature ceramic glass supplied by Morsø, contact your Morsø dealer.

Installing the glass

Never install the glass when the stove is in function.

Ceramic glass replacement

Ceramic glass cannot be recycled because it has a higher melting point than ordinary glass. If ceramic glass is mixed with ordinary glass, the raw material is spoiled, and the reclaiming process may be halted. Take care that the ovenproof glass does not end up among ordinary recycled waste. That will be a great benefit to the environment.

Note: Should be handed in to a recycling station as ceramic glass.

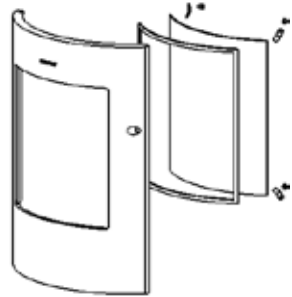

1. When you open the door, you will find two hinge pins, one in each hinge. Remove the two hinge pins, lift the door off the hinges and place it face down on a sheet of cardboard or other nonabrasive fabric.
2. Unscrew the 4 bolts that secure the glass. (In the event that a bolt sheers off when being unscrewed, remove the remaining body of the bolt by drilling down its centre with 1/8 inch high speed steel drill bit. Smaller drill bits may be successful, but do not use a larger bit. Make sure the bit stays away from the edges of the bolt - this may damage the thread in the cast iron).
3. Remove the old ceramic gaskets and clean up the surface underneath with wire wool or emery paper to remove loose particles.
4. Place the new gasket material in position around the perimeter of the window area, making sure to pinch them to the length in such a way that they make a continuous seal. Leave no gaps.
5. Place the new glass in position on the strips and screw home the fresh bolts and fitting by hand.
6. Finally, give each of the bolts an extra half turn or so. The glass should be held tight enough by that cleaning will not dislodge it. Do not over-tighten the bolts as this may put excessive pressure on the glass, resulting in cracking - important!

To reduce the risk of breaking the glass, avoid striking the glass or slamming the door.

Internal service parts

The flame-path equipment - consisting of the ashpan, grate, firebricks, Cast iron fire plates, glass, baffle and flue collar - are subject to the extremes of heat produced by the fire. From time to time, one or other of these parts may need replacing as a matter of routine maintenance.

NOTE: The flame-path equipment, the ceramic rope and the paint finish are not covered by guarantee.

All of these service parts can be bought from your morsø dealer, and we recommend that damaged parts are replaced as soon as possible to avoid collateral damage.

Should the baffle be distorted by an overfire, the stove will still function, although its efficiency may be compromised. Replace it as soon as possible.

Reasons for fast internal wear and tear

Persistent heavy firing

Soot and ashes left to accumulate

Gasket

The gasket around the perimeter of the door may harden over a period of time. It should be replaced if it becomes difficult to close the doors or if air starts to leak in around the perimeter of the doors, causing the fire to become a little less controllable. A morsø rope gasket kit is available from your stove supplier.

3.3 Cleaning the Stove and the Flue

Check for soot above the baffle plate and around the flue outlet every month or so to start with. If the stove suddenly becomes sluggish, check for a soot fall around the flue collar or in the flue/chimney.

The chimney and chimney connector should be inspected at least once every two months during the heating season to determine if a creosote buildup has occurred. If creosote has accumulated, it should be removed to reduce the risk of a chimney fire.

Clean the flue/chimney - all the way from the stove to the flue terminal point above the house.

A good routine is to clean the flue after each heating season in any case, and inspect prior to the season to ensure that bird's nests or other blockages have not occurred during the off season.

Ash disposal

Empty the ashpan on a daily basis or as needed. Ash allowed to build up towards the underside of the grate will trap heat and could cause premature failure of the grate.

Empty the ashpan according to this procedure:

Open the front door, and use a shovel or poker to stir excess ash through the ash slots in the grate down into the ash pan. Take out the ash pan, making sure to keep it level to avoid spilling ash.

Dispose the ash in a metal container with a tight fitting lid.

The closed container of ashes should be placed on a noncombustible floor or on the ground, well away from all combustible materials, pending final disposal. If the ashes are disposed of

by burial in soil or otherwise locally dispersed, they should be retained in the closed container until all cinders have thoroughly cooled.

Return the ash pan to its original position in the stove, and close the door.

Caution:

Never empty a stove in operation.

Never use your household or shop vacuum cleaner to remove ash from the stove; always remove and dispose of the ash properly.

Creosote - formation and need for removal

When wood is burned slowly, it produces tar and other organic vapors, which combine with expelled moisture to form creosote. The creosote vapors condense in the relatively cool chimney flue of a slow-burning fire. As a result, creosote residue accumulates on the flue lining. When ignited this creosote makes an extremely hot fire. When burning wood, the chimney and chimney connector should be inspected at least once every two months during the heating season to determine if a creosote buildup has occurred. If creosote has accumulated, it should be removed to reduce the risk of a chimney fire.

Chimney sweeping

Inspect the system regularly during the heating season as part of a regular maintenance schedule. To inspect the chimney, let the stove cool completely. Then, using a mirror, sight up through the flue collar into the chimney flue. If you cannot inspect the flue system in this fashion, the stove must be disconnected to provide better viewing access.

Clean the chimney using a brush the same size and shape as the flue liner. Run the brush up and down the liner, causing any deposits to fall to the bottom of the chimney where they can be removed through the clean-out door.

Clean the chimney connector disconnecting the sections, taking them outside, and removing any deposits with a stiff wire brush. Reinstall the connector sections after cleaning, being sure to secure the joints between individual sections with sheet metal screws.

If you cannot inspect or clean the chimney yourself, contact your local Morsø Dealer or a professional chimney sweep.

If you do experience a chimney fire, act promptly and:

Close the air control.

Get everyone out of the house.

Call the Fire Department.

Annual maintenance

Before the heating season, perform a thorough cleaning, inspection and repair:

Thoroughly clean the chimney and chimney connector.

Inspect the chimney for damage and deterioration. Replace weak sections of prefabricated chimney. Have a mason make repairs to a masonry chimney.

Inspect the chimney connector and replace any damaged sections.

Check gasketing for wear or compression, and replace if necessary.

Check the glass for cracking; replace if needed.

Check door and handle for tightness. Adjust if needed.

How to clean the inside parts of Morsø 6170

When cleaning the inside parts of the stove in connection with the annual visits from your local chimney sweep we recommend that you remove the inside parts from the fire chamber. Please be careful as the vermiculite parts are porous. Cleaning of the stove must be done when the stove is cold.

1. The bottom baffle is lifted up a bit and held in that position. Loosen the side bricks.



2. Tip the side bricks and remove them from the fire chamber.



3. Tip the other side brick and remove it from the fire chamber.



4. When the side bricks are removed the bottom baffle is lowered and lifted out of the fire chamber.



5. The upper baffle is removed from the brackets and lifted out of the firechamber.



3.4 Leaving the stove for extended periods

Important:

If the stove is to be left unused for any period of time, clean it out thoroughly and leave the air control slightly open to allow airflow. Make sure that the flue does not allow rainwater to come anywhere near the stove; install a chimney cap, but do not block off the flue completely.

These measures should ensure there is a slight movement of air through the stove, and that the body of the stove remains dry, right into the corners.

Any ash left within an unfired stove can attract moisture like blotting paper. If moisture is allowed to settle within the stove, rust will form. Rust expands as it takes a grip. This can lead to undue pressure on the stove joints, and this in turn may result in damage to the stove.

NOTE: It is best to thoroughly clean the stove after the heating season has concluded. Adding a dessicant, such as kitter litter, into the ash pan helps absorb moisture during the summer months. Be sure to remove this prior to the heating season.

We hope you have many years of carefree warmth in its company. Some initial experimentation with loading and running techniques will decide your normal routine. If you have any problems after this short learning phase, please refer to your stove dealer. Should they be unable to help for any reason, please contact us in writing at the address on the front of this publication.

3.5 Parts diagram for model Morsø 6100

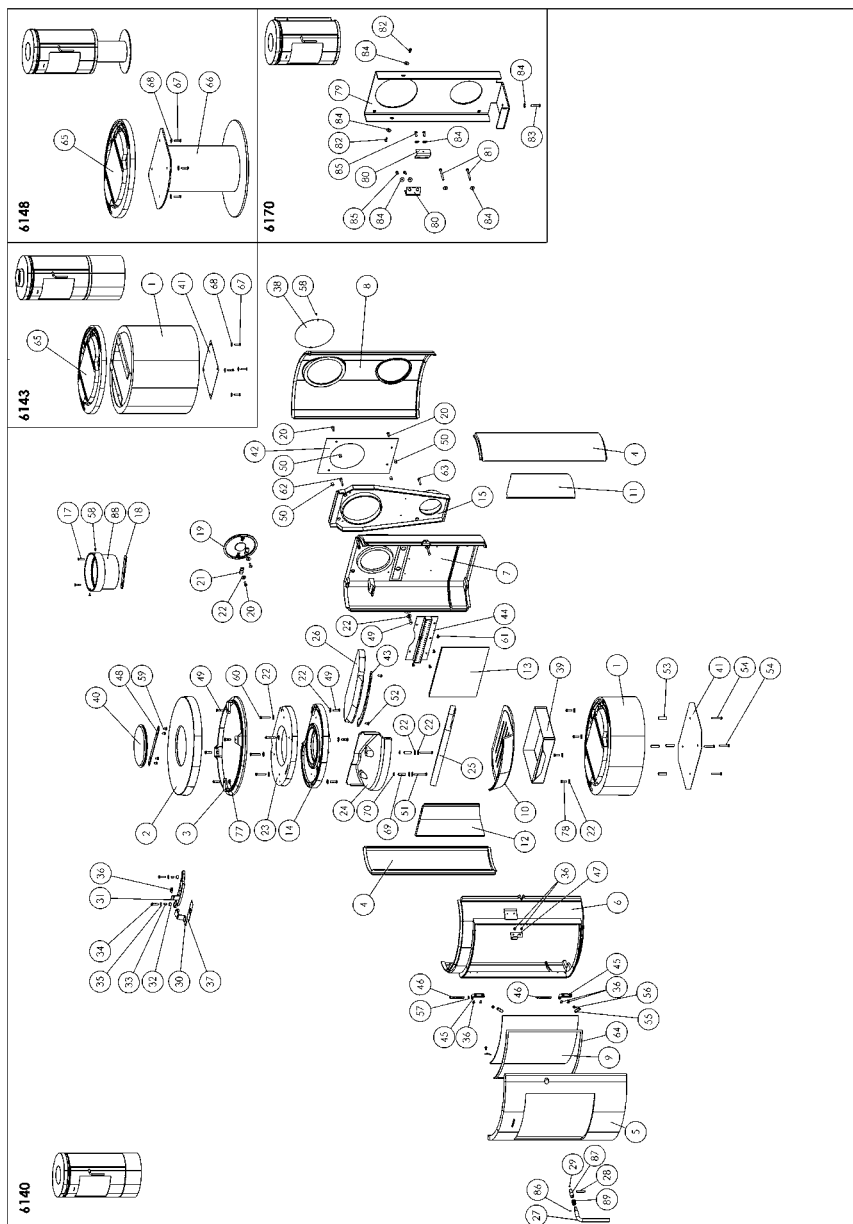

3.6 Parts list for model Morsø 6100

Posnr.	Parts:	6170 NA
1	Socle	%
2	Top plate, outside	446109xx
3	Top frame	446106xx
4	Side plate, outside	446107xx
5	Door	446103xx
6	Front frame	446102xx
7	Rear plate, inside	446104xx
8	Rear plate, outside	446124xx
9	Glass	79610100
10	Intermediate frame	346110
11	Brick, side, right	79610200
12	Brick, side, left	79610300
13	Brick, back	79610400
14	Top plate, inside	44610500
15	Air canal, rear	44612500
16	Flue collar	%
17	Screw	%
18	Stop bar	%
19	Cover	441410xx
20	Screw	731616
21	Lug	44256800
22	Washer	791891
23	Air canal, top	446113xx
24	Air canal, front	446116xx
25	Baffle plate, lower	79610500
26	Baffle plate, top	79610600
27	Handle	75610061
28	Hinge pin	542056
29	Screw	73950500
30	Handle f. sek. draught control	71611261
31	Sek. draught control	71611100
32	Distance tube	71810300
33	Distance tube	71810200
34	Screw	74162000
35	Washer	736106
36	Screw	73851100
37	Closing plate for sek. draught control	71610800
38	Roundel	716110xx
39	Ash can	71610100
40	Cover	448120xx
41	Radiant shielding, bottom	%
42	Radiant shielding, rear	71612200
43	Fitting plate for baffle	71610461
44	Tertiary box	71610561
45	Hinge fitting	718101xx
46	Screw	74701000

Posnr.	Parts:	6170 NA
47	Closing fitting	71610700
48	Lug for cover	71813200
49	Screw	731625
50	Distance tube	541439
51	Screw	731650
52	Screw	731612
53	Distance tube	%
54	Screw	%
55	Glass fitting	71814561
56	Screw	73850800
57	Washer	746006
58	Screw	791835
59	Screw	731608
60	Screw	731640
61	Screw	74361000
62	Screw	731635
63	Screw	731630
64	Tape for glass	79074200
65	Bottom plate	446126xx
66	Pedestal	%
67	Screw	%
68	Washer	%
69	Distance tube	541440
70	Washer	746206
71	Flue collar	441419xx
72	Stop bar	71611800
75	Spring	%
76	Screw	%
77	Washer	736210
78	Screw	731620
79	Fitting for wall	716120xx
80	Fitting for fitting for wall	716121xx
81	Screw	73166000
82	Screw	73861400
83	Screw	731635
84	Washer	791891
85	Screw	731612
86	Cotter pin	74201900
87	Axle f. door	75610161
88	Flue collar	446118xx
89	Spring	79048800