

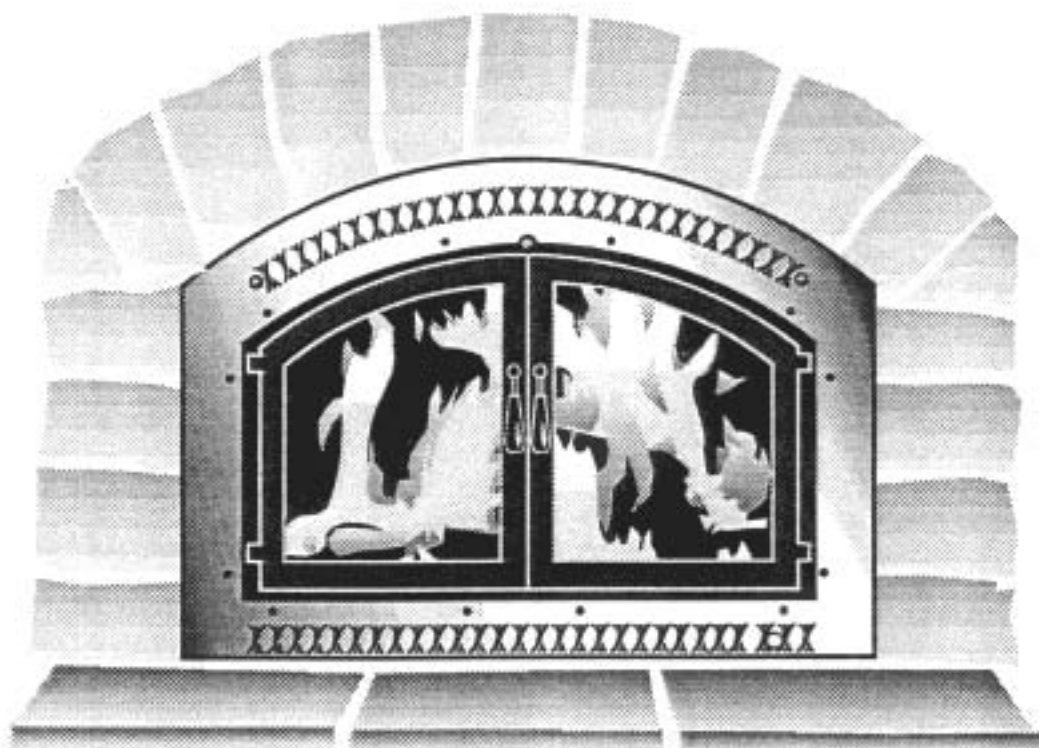

FIREPLACE XTRODINAIR™

OWNER'S MANUAL

JANUARY, 1996



MODEL 44A-BI
MODEL 44A-ZC

Tested To U.L. 127, U.L. 1482, U.L. 907
Standards By:
Warnock Hersey Professional
Services, Ltd.



MANUFACTURED BY
Travis Industries

10850 117TH PLACE NE
KIRKLAND, WA 98033

SAFETY PRECAUTIONS

- VIEWING DOOR MUST BE CLOSED AND LATCHED DURING OPERATION.
- THIS APPLIANCE HAS BEEN DESIGNED AND TESTED FOR BURNING OF WOOD OR NATURAL GAS ONLY. THE BURNING OF ANY TYPE FUEL OTHER THAN WOOD OR NATURAL GAS WILL VOID THE WARRANTIES AND SAFETY LISTINGS OF THE APPLIANCE. DO NOT ATTEMPT TO BURN ANY OTHER FUEL THAN THOSE SPECIFIED IN THIS MANUAL. NOTE: WHEN USING NATURAL GAS YOU SHOULD FOLLOW THE OPERATING INSTRUCTIONS THAT ARE SUPPLIED WITH THE NATURAL GAS LOG SET OR LOG LIGHTER.
- THIS APPLIANCE MUST BE PROPERLY INSTALLED IN ORDER TO PREVENT THE POSSIBILITY OF A HOUSE FIRE. FOR YOUR SAFETY THE INSTALLATION INSTRUCTIONS MUST BE STRICTLY ADHERED TO. DO NOT USE MAKESHIFT METHODS OR COMPROMISE IN INSTALLATION.
- THE EXHAUST SYSTEM SHOULD BE CHECKED TWICE A YEAR MINIMUM FOR ANY BUILD-UP OF SOOT OR CREOSOTE.
- CONTACT YOUR LOCAL BUILDING OFFICIALS TO OBTAIN A PERMIT AND INFORMATION ON ANY INSTALLATION RESTRICTIONS OR INSPECTION REQUIREMENTS IN YOUR AREA. ALSO, NOTIFY YOUR INSURANCE COMPANY THAT YOU ARE INSTALLING YOUR WARNOCK HERSEY LISTED FIREPLACE.
- NEVER BLOCK FREE AIRFLOW THROUGH OPEN VENTS.
- GASOLINE OR OTHER FLAMMABLE LIQUIDS MUST NEVER BE USED TO START THE FIRE OR "FRESHEN-UP" THE FIRE. DO NOT STORE OR USE GASOLINE OR OTHER FLAMMABLE LIQUIDS IN THE VICINITY OF THIS APPLIANCE.
- ASHES MUST BE DISPOSED OF IN A METAL CONTAINER WITH A TIGHT FITTING LID, AND PLACED ON A NON-COMBUSTIBLE SURFACE BEFORE FINAL DISPOSAL.
- NEVER TRY TO REPAIR OR REPLACE ANY PART OF THE APPLIANCE UNLESS INSTRUCTIONS ARE GIVEN IN THIS MANUAL. ALL OTHER WORK SHOULD BE DONE BY A TRAINED TECHNICIAN.
- DO NOT MAKE ANY CHANGES OR MODIFICATIONS TO THE APPLIANCE OR AN EXISTING MASONRY FIREPLACE OR CHIMNEY TO INSTALL THIS APPLIANCE.
- WAIT UNTIL THE APPLIANCE HAS COOLED BEFORE CARRYING OUT MAINTENANCE PROCEDURES.
- TRAVIS INDUSTRIES, INC. GRANTS NO WARRANTY, IMPLIED OR STATED, FOR THE INSTALLATION OR MAINTENANCE OF YOUR APPLIANCE, AND ASSUMES NO RESPONSIBILITY FOR ANY CONSEQUENTIAL DAMAGE(S).
- ALWAYS FOLLOW THE INSTRUCTIONS IN THE OWNER'S MANUAL.
- KEEP THIS MANUAL FOR LATER USE.

IMPORTANT INFORMATION

Introduction	1
Safety Precautions	2
Features And Specifications.....	4
Chimney Size And Proper Draft.....	5
Protecting The Gold On The Fireplace Xtrordinair	6

OPERATING YOUR APPLIANCE

Location and Use of Controls	7
Burning Procedure	8
Maintaining Catalytic Light-Off	9
Burning Your Appliance Efficiently	10
Daily Use of Your Appliance.....	10
Wood.....	11
Seasoning Wood.....	12
Storing Wood.....	14
Safety in Operation.....	16

CARE AND MAINTENANCE

Maintenance Schedule	17
Maintenance Instructions	17

BEFORE CALLING FOR SERVICE

Before Calling For Service.....	23
---------------------------------	----

REPLACEMENT PARTS AND REMOVAL INSTRUCTIONS

Replacement Parts	24
Removal Instructions.....	24

ADDITIONAL INFORMATION

5-Year Warranty.....	29
Safety Label.....	30

FEATURES AND SPECIFICATIONS

- EPA Phase II approved.
- Heavy duty steel construction.
- Thermostat for automatic control of the blower.
- Large firebox capacity - 4.3 cu. ft.
- Long burn time - 12 Hours.
- Large glass doors for maximum visibility.
- Firebrick lining for firebox protection.
- 388 CFM blower for convection heat and outside combustion air.
- Gas line sleeve through the left side of the firebox for easy installation of gas log lighter or gas log set

Heating Capacityup to 3,000 sq. ft. maximum
 BTU Output/hr10,700 to 75,700
 Overall Efficiency77 % (DEQ Method)
 Emissions grams/hr2.3 (EPA Method)
 Maximum Burning Time.....12 Hours
 Fuel.....Solid Wood or Natural Gas
 Flue Opening Diameter8 in.

Overall Width (Not Including Faceplate).....
 Overall Depth.....

44A-BI	44A-ZC
39 in.	49 in.
23	27 in.

Emissions, Efficiency, Heating Capacity and Burn Times may vary depending on actual home floor plan, type of fuel used, and moisture content. Emissions and efficiency numbers are those that have been certified by the U.S. E.P.A. and the Oregon Department of Environmental Quality.

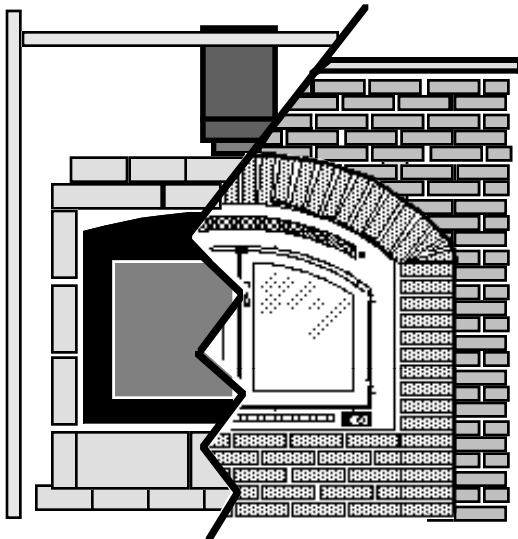

44A-BI

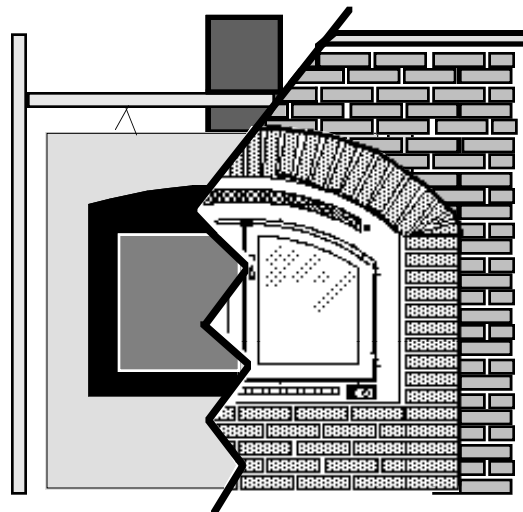

44A-ZC

CHIMNEY SIZE AND PROPER DRAFT

Your Fireplace Xtrordinair comes with a set of installation instructions. These instructions should be followed by the installer and kept for future reference. Before installing the fireplace the chimney's size and draft should be verified. The installation instructions contain all of the specific information for chimney size and installation. The information below outlines this information on chimney size and draft.

Draft is the force which moves air from the appliance up through the chimney. The amount of draft in your chimney depends on the length of chimney, local geography, nearby obstructions and other factors. Too much draft may cause excessive temperatures in the appliance and may damage the catalytic combustor. Inadequate draft may cause back-puffing into the room and plugging of the chimney or the combustor. The performance of your fireplace depends a great deal on the type and size of your chimney as well as its location. Your fireplace dealer should have covered the importance of this when you purchased your fireplace. If you experience any of the above problems, check for the following and correct.

1. **IMPROPER CHIMNEY HEIGHT:** Your chimney must extend above the roof to the proper height in order to promote sufficient draft. If the chimney doesn't extend at least 3' above a flat roof or at least 2' higher than any point within 10' on a pitched roof then your chimney may have to be extended (see the installation instructions for more details). This will be especially true if you experience a lazy slow burning fire or smoking into room when you open the loading doors. Don't mistake these symptoms for trying to burn wet wood.

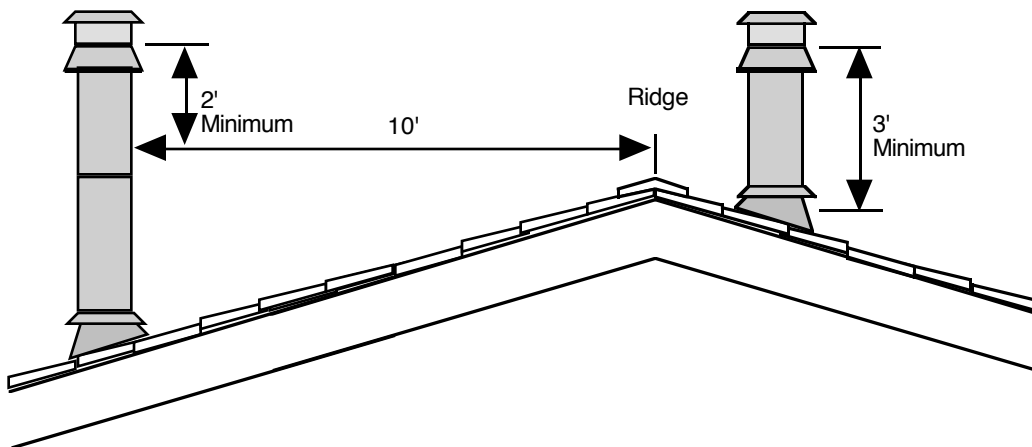

2. **CHIMNEY SIZE:** Your Fireplace Xtrordinair is tested with 8" ID metal chimney and 12" x 12" clay flue liner. The use of any other size is not recommended and is likely to cause problems in achieving proper draft.
3. **ELBOW RESTRICTIONS:** If the chimney has too many elbows it will reduce the draft and you may have to extend the chimney to increase the draft (see installation instructions for more details and certain restrictions).
4. **COLD AIR BLOCK:** If the chimney is located outside of the home, it will not heat up as well to create a draft. This will especially be true of masonry chimneys in cold weather. Starting a paper fire in the firebox will in most cases put sufficient temperature in the chimney to start a draft before beginning to add kindling.
5. **TREES OR OTHER TOPOGRAPHICAL BARRIERS CLOSE TO CHIMNEY:** Anything close to the chimney that is taller than the chimney will in some way affect the draft. These types of influences can generally be corrected by caps that isolate the chimney like wind directional or vacuum caps.

PROTECTING THE GOLD ON THE FIREPLACE XTRODINAIR

Gold is the very best material available for plating fireplace fronts, but it is not indestructible. The most common complaint with any plated surface on a wood burning appliance is discoloration. This can only be caused by heat or chemicals. The discoloration is permanent and cannot be removed. The following warnings will help you protect the shine in the gold plating.

NOTE: IF YOU ARE INSTALLING YOUR FIREPLACE XTRODINAIR INTO A NEW MASONRY OR BLOCK-IN FIREPLACE, YOU SHOULD READ THE FOLLOWING WARNING ON ACID WASH:

Acid Wash Warning:

In the past gold faceplates and/or doors have become severely tarnished as a direct result of acid wash that has not been properly neutralized on masonry fireplaces. This condition occurs when the masonry fireplace is newly constructed and muriatic acid is used to remove excess mortar. If the mason does not adequately neutralize this muriatic acid with ammonia and water, the acid will be left on the brick. Whenever the fireplace is heated, either from a fire or from room heat, acid vapors will be released from the brick. These vapors are extremely corrosive and will attack any metal surface in the immediate area of the fireplace. Gold plated surfaces will develop a cloudy film.

Replacement of the faceplate and/or doors **WILL NOT CURE THIS PROBLEM!** The correct repair is to have the masonry contractor come out to the house and wash down the entire fireplace face to neutralize this acid condition. If this is a new home, the repair should be covered under warranty by the home builder. If this is an older home, the consumer may have some recourse from the seller. We stress that this condition is not a defect in the manufacture of the plating, but an acid problem with the brick or stone of the fireplace face.

You can test your brickwork for improper neutralization by using a spa or pool test strip which is available at spa and pool stores. Apply one drop of water to your brick and touch the test strip to the brick (Refer to instructions on the packaging when reading the test strip). If the strip shows a high acid content you will need to take steps to properly neutralize your brick. Please be aware that the warranty for your Fireplace Xtrordinair will not cover damage to the plating as a result of an improperly neutralized acid wash.

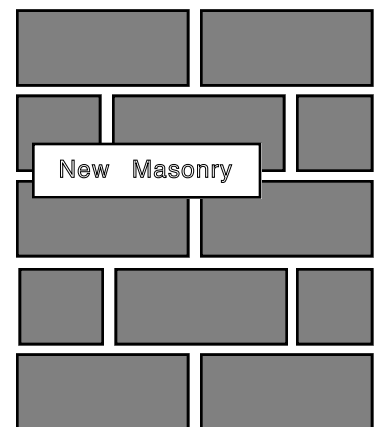

Heat Warning:

Gold plating is inherently resistant to heat and will not discolor under normal conditions. However, there are some conditions that may damage the gold surfaces due to excessive heat you should be aware of.

The Fireplace Xtrordinair was designed and safety tested to withstand a full load of normal wood burning at the highest burn rate. However, do not use the fireplace continuously at this high-temperature level. Be careful with hot-burning wood (dense wood or wood that is in small pieces). If any part of the interior of the fireplace is glowing red, the fireplace is over-fired and should be turned to a lower burn rate and allowed to cool down. Also be aware of excessive temperatures due to a power outage shutting off the blower. With the blower disconnected from power, the heat from the fireplace will build up quicker and not dissipate as well. During power outages, do not run the fireplace at high burn rate settings.

OPERATING YOUR APPLIANCE

Location and Use of Controls

NOTE: The Combustion Air Control and Combustor By-Pass Control become hot during operation. Use a glove to adjust these controls while the appliance is hot.

Combustion Air Control

The Combustion Air Control is located in the center over the door and is operated by sliding it from left to right. When the control is completely to the left, it is in the fully open position. When it is completely to the right, it is in the fully closed position.

Combustor By-Pass Control

The Combustor By-Pass Control is located on the upper right of the appliance and is operated by pushing or pulling the control. When pulled out all the way, the catalytic combustor is bypassed.

Blower Speed Control

The blower system is controlled by a thermostat located under the firebox which turns the blower on automatically as the firebox heats up (approximately 45 minutes from start). The blower will continue to run as long as the firebox has sufficient heat. Adjust the blower speed by turning the control knob in the lower right corner of the fireplace face (see the illustration below). For low heat range settings operate at the lowest setting and increase the air flow as the heat range setting is increased by turning the control knob clockwise. The fireplace is equipped with an automatic blower shut off switch to shut off the blower when the doors are opened. The blower will always run as long as the firebox has sufficient heat and the doors remain closed.

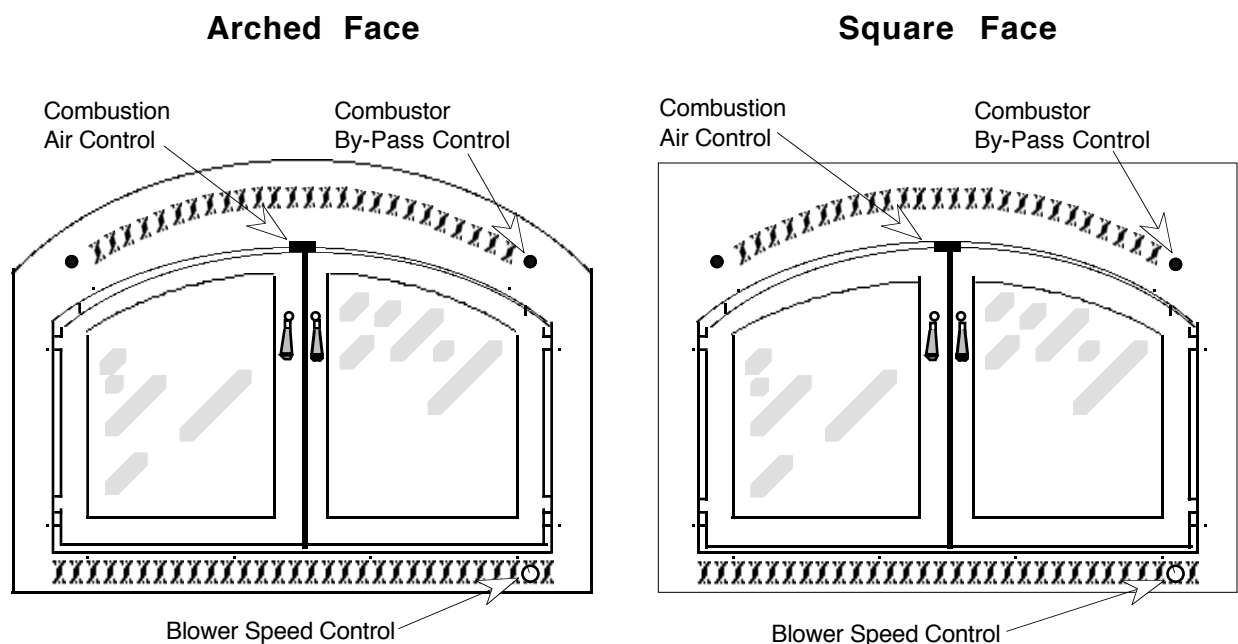

OPERATING YOUR APPLIANCE (Continued)

To build a fire in disregard of the information provided in this section can cause permanent damage to your appliance and void your warranty.

This appliance is not designed for use with the door open. Burning with the loading door open could create a safety hazard.

Burning Procedure

1. Open the door and place some paper and kindling or a solid wax impregnated firestarter inside the appliance.
2. Make sure that the combustion air intake control is fully open by pushing the control knob all the way to the left. Pull the combustor by-pass control, located on the upper right of the appliance, all the way out.
3. Now light the fire. Close the doors against the latch but do not lock them, this will help create a draft to start the fire. Once the kindling is burning, add some small dry pieces of wood and close the loading door. NOTE: The first two or three fires in your new appliance will cause the high temperature paint to give off a slight odor and a small amount of smoke. This is the paint curing. For best results during the curing of the paint, burn small intense fires so the appliance does not overheat. The high temperature paint cures best at medium temperatures. To prevent the door gasketing from sticking to the seasoning paint during the first few operations, open the doors slowly and often. Also, the viewing glass may become somewhat obscure the first few times, as your appliance is drying all moisture from bricks and even the steel itself. During the first few fires it may be a little harder to start the fire because the firebricks will contain some moisture.
4. Next add two or three medium size dry logs (use of green or wet wood in your appliance will develop creosote, cloud glass, and greatly decrease its efficiency). At this time establish a hot fire with a bed of red hot coals. Once the fire is well established, close and latch the doors.
5. To slow the rate of burn, close (push to right) the combustion air control as needed.

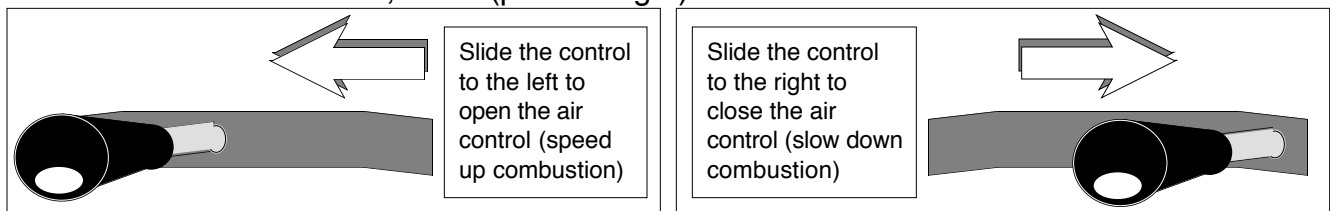

6. The combustor by-pass control should be pushed in only when the appliance has reached operating temperature (usually 20 to 30 minutes).
7. When adding wood to the fire, first open the combustion air control (all the way left) and combustor by-pass control (all the way out) before opening the loading doors. this will prevent the possibility of smoke spillage into your house and insure that the catalytic combustor does not lose its operating temperature.

NOTE: Do not open the door of your appliance when the air control inlet is fully closed. There is a possibility with a solid fuel burning appliance that doing so could result in a sudden flash of flames as the fire ignites with oxygen. However, your Fireplace Xtrordinair has been thoroughly safety tested to reduce this possibility. Keep all wood behind the log retainer. Over-restricting the amount of combustion air into the appliance will cause creosote build-up on glass and in the appliance and flue. This will also greatly decrease the efficiency of the appliance.

OPERATING YOUR APPLIANCE (Continued)

Maintaining Catalytic Light-Off

Your Fireplace Xtrordinair is equipped with a catalytic combustor which increases the efficiency of your appliance. It is located along the roof of the firebox and is accessed from within. Its purpose is to re-ignite the flue gases before they exit up the chimney. This process, called catalytic light-off, increases the heat output of your fireplace and reduces the amount of emissions.

While starting a fire the catalytic combustor is by-passed to allow the fire to get up to temperature. Once the fire is up to temperature the combustor by-pass control can be pushed in to allow the flue gases to be routed through the catalytic combustor. The amount of time it takes for the fire to get up to temperature varies depending upon the amount of draft and quality of wood. In most cases the appliance is up to temperature in 30 minutes or less.

When to Push in the Combustor By-Pass

The temperature in the appliance and the flue gases entering the combustor must be raised to between 500 and 700 degrees F. for the catalytic combustor to work correctly. During the start up of a cold appliance a medium to high heat range setting must be maintained for a minimum of 20 minutes. This insures that the appliance, catalyst and fuel are all stabilized at their proper operating temperature. Even though it is possible to have gas temperatures reach 600 degrees F. within 2 to 3 minutes after a fire is started, if the fire is allowed to die down immediately it may go out and the combustor may stop working. Once the combustor starts working, the heat generated in it by burning the smoke will keep it working.

What to do After Refueling Your Fireplace

During the refueling and rekindling of a cool fire or a fire that is in the charcoal phase, operate the appliance at a medium to high firing rate for about 10 minutes to insure that the catalyst reaches approximately 600 degrees F. This will insure catalytic light-off.

CATALYTIC LIGHT-OFF

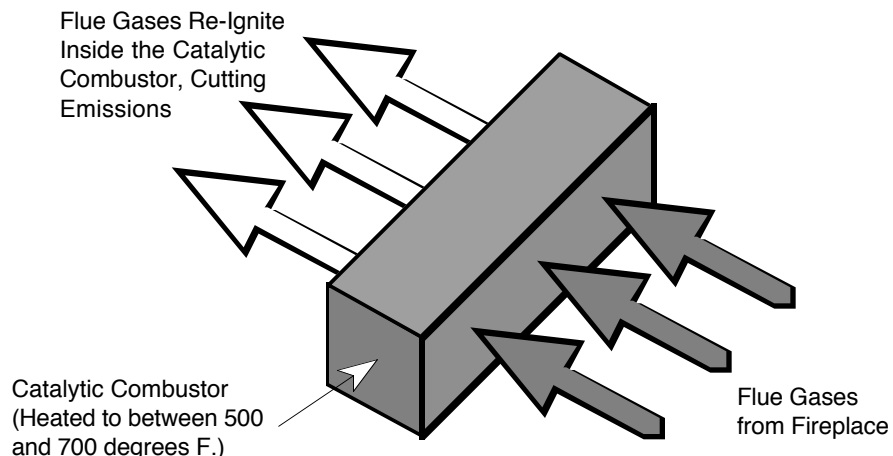

OPERATING YOUR APPLIANCE (Continued)

Burning Your Appliance Efficiently

Your Fireplace Xtrordinair is designed to heat your home efficiently with the lowest amount of creosote build-up and pollutants emitted. The following steps provide a guideline to efficient burning:

On cold days, when you wish for high heat output from your appliance, load the appliance fully after the fire has been established and burn at a medium-high to high burn mode. When a comfortable heat level in your home has been reached, subsequent loadings would be of lesser amounts of wood. On warmer days, burn smaller fires, using less wood. This method will give you the most efficient burn possible.

Although the fire will burn longer at a lower setting, your appliance will not produce as much heat and it will increase soot accumulation on the appliance, chimney and glass.

For an overnight burn, establish a hot fire. Before you are ready to retire, completely fill the appliance with wood. With the controls in the fully open position, let the fire burn intensely for 10 to 15 minutes. Next adjust the draft control so that a low, lazy flame is visible. In the overnight burn, you should be able to maintain a fire for about 10-12 hours, depending on the type of wood used, and still have a coal bed, with no visible flame, left to start the morning fire. To re-establish a fire after an overnight burn, open the controls fully and stir the ashes to bring hot coals to the surface. Then load more wood to re-establish the fire. If you dampen the fire down too low, you will not only lower the heat output, but you will be promoting creosote build-up. It will take a few days of practice to achieve the desired settings.

APPROXIMATE COMBUSTION AIR CONTROL SETTINGS

TYPE OF BURN RATE

AIR CONTROL SETTING

Overnight Burn	Fully Closed
Medium Burn	Open 1/16"
Medium High Burn.....	Open 1/8" to 3/8"
High Burn	Fully Open

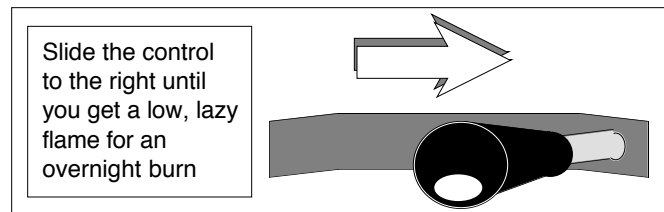
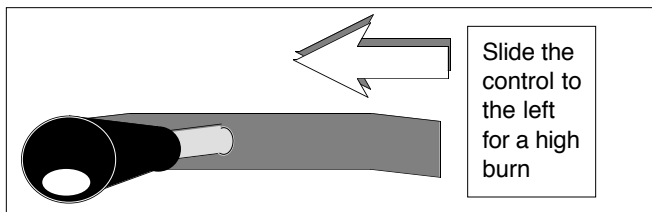

Daily Use of Your Appliance

Some helpful hints: After loading your appliance, open the air control and allow your appliance to burn vigorously for 20 or 30 minutes. This will assist in the burn-off of any creosote which accumulates over periods of extended use at low settings.

OPERATING YOUR APPLIANCE (Continued)

Wood

This appliance is designed to burn natural wood only. Higher efficiencies and lower emissions generally result when you burn air dried, seasoned hardwoods as compared to softwoods or to green or freshly cut hardwoods. **DO NOT BURN** treated wood, garbage, solvents, trash, coal, cardboard, colored paper, or wax impregnated logs (i.e. Duraflame, etc.). Burning treated wood, garbage, solvents, colored paper or driftwood from salt water may result in release of toxic fumes and may render the appliance ineffective and void the limited warranty. Burning coal, cardboard or loose paper can produce soot, large flakes, char or fly ash that can coat the inside of your appliance, causing smoke spillage into the room.

Choosing the kind of firewood to burn in your appliance depends on what is available to you. If all you can obtain is softwoods, obviously, that will be your choice.

Softwoods such as pine and fir are easily ignited and burn rapidly with hot flames. Since they burn so easily and quickly you will have to spend more time loading your firebox, especially in the high burn mode. With softwoods it will be much more difficult to achieve an overnight burn. Furthermore, softwoods make it necessary to reload the appliance more often. The chart below outlines the advantages of using hardwood.

SPECIES*	LBS./CORD**	BTU's/CORD**	Hours per Cord at 40,000 BTU's per Hour**
ALDER	2540	19,050,000	476
APPLE	4400	33,000,000	825
ASH	3440	25,800,000	645
BIRCH	3040	22,800,000	705
CEDAR	2060	15,450,000	386
COTTONWOOD	2160	16,200,000	405
DOGWOOD	4320	31,725,000	793
ELM	2260	16,950,000	423
FIR, DOUGLAS	2970	22,275,000	556
HEMLOCK	2700	20,250,000	506
MAPLE	3200	24,000,000	600
OAK, RED	3680	27,600,000	690
OAK, WHITE	4200	31,500,000	787
PINE	2250	16,875,000	421
REDWOOD	2400	18,000,000	450
SPRUCE	2240	16,800,000	420

* At 20% moisture content

** All values are approximate

If you have a choice it is best to use the more dense hardwoods for a longer lasting fire. The best arrangement is to have a mix of softwoods and hardwoods for ease of start-up and a longer lasting fire. Also, it is a good idea once the fire is established to use larger diameter logs stacked tightly together. This will promote a longer burn time.

Wood is typically sold by the "cord". A cord is a nicely stacked pile of logs measuring 4 feet wide by 4 feet high by 8 feet long. Always look for the driest wood especially if you purchase your wood by weight. Unseasoned, wet wood is much heavier.

Moisture content of the wood greatly affects the way any appliance operates. Well seasoned wood (split, stacked and kept dry for at least 12 months) is your best fuel choice.

OPERATING YOUR APPLIANCE (Continued)

Wood (Continued)

Wet wood not only causes more work for you due to the increase in weight making it more burdensome to carry, but most importantly it will not burn as efficiently. You will receive less heat output from a wet piece of wood because it wastes energy evaporating the water, energy that should be used for heating your home. When a wet piece of wood is placed in your appliance it will also cause more creosote accumulation on the glass, in the appliance, flue and chimney. The primary reason for this is, as the water evaporates from the wood it will "spit" creosote-like material. If you can hear your wood sizzle or you can see moisture bubbling from the ends of the logs placed in a HOT appliance, your wood is too wet! Another big advantage to burning seasoned wood, aside from higher efficiency and less creosote, is LESS POLLUTION!

Seasoning Wood

Green wood will burn, but seasoned or dry wood is lighter, has more heat value, and is less apt to form creosote deposits. Any moisture in the wood reduces the recoverable heat because water absorbs heat in the process of being changed to steam. The net heat from a pound of completely dry (no moisture) hardwood is about 7,950 BTU's. All wood has some moisture in it which reduces the net usable heat at a rate of 1,200 BTU's per pound of water.

The moisture in the wood of living trees varies among species, within a species, and even within individual trees. Frequently, there is a significant difference between the quantity of moisture contained in the central column of heartwood of a tree and the outer layers of sapwood which is surrounded with bark. For example, freshly cut American beech has been found to have a heartwood moisture content of 72%. In contrast, heartwood moisture contents in American elm, northern red oak, and white ash are 95, 80 and 46%, respectively.

When drying wood, the greater the surface area exposed to the air, the more rapid the drying. Therefore, stack the wood in loose piles that are raised off the ground. Wood greater than 8 inches in diameter or longer than 4 feet dries very slowly. Reduce the size of such sticks by splitting and/or sawing.

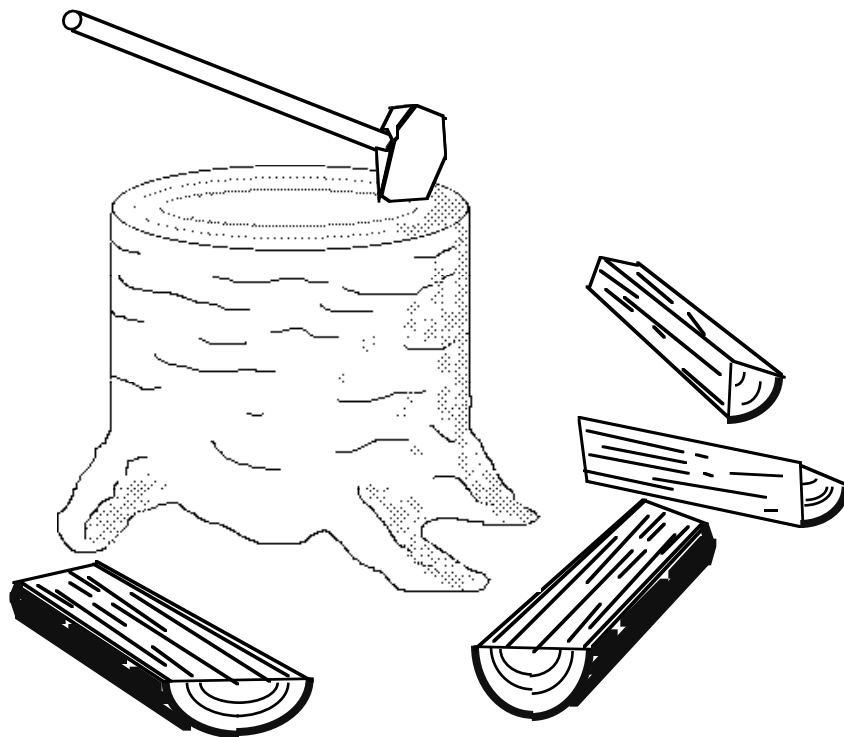

OPERATING YOUR APPLIANCE (Continued)

Seasoning Wood (Continued)

Place firewood in an open area to obtain rapid drying and to prevent deterioration. Preferably, put a cover on the top tier of wood. If you cut trees in summer, let them lie for a week. The leaves will draw moisture from the wood and dry it more quickly than if you limb the tree immediately.

Seasoning can be accelerated greatly by simply stacking fuelwood in a sunny location and then covering it with clear plastic sheeting. In sunny weather, temperatures within the plastic covering will rise much higher than outside, warming the wood and evaporating the contained moisture. The water vapor produced either escapes or condenses on the plastic covering; therefore some arrangement for ventilation is necessary. It is also desirable to hold the plastic away from the rough ends of the wood to prevent abrasion, allow air to flow, and keep any condensation from re-wetting the wood.

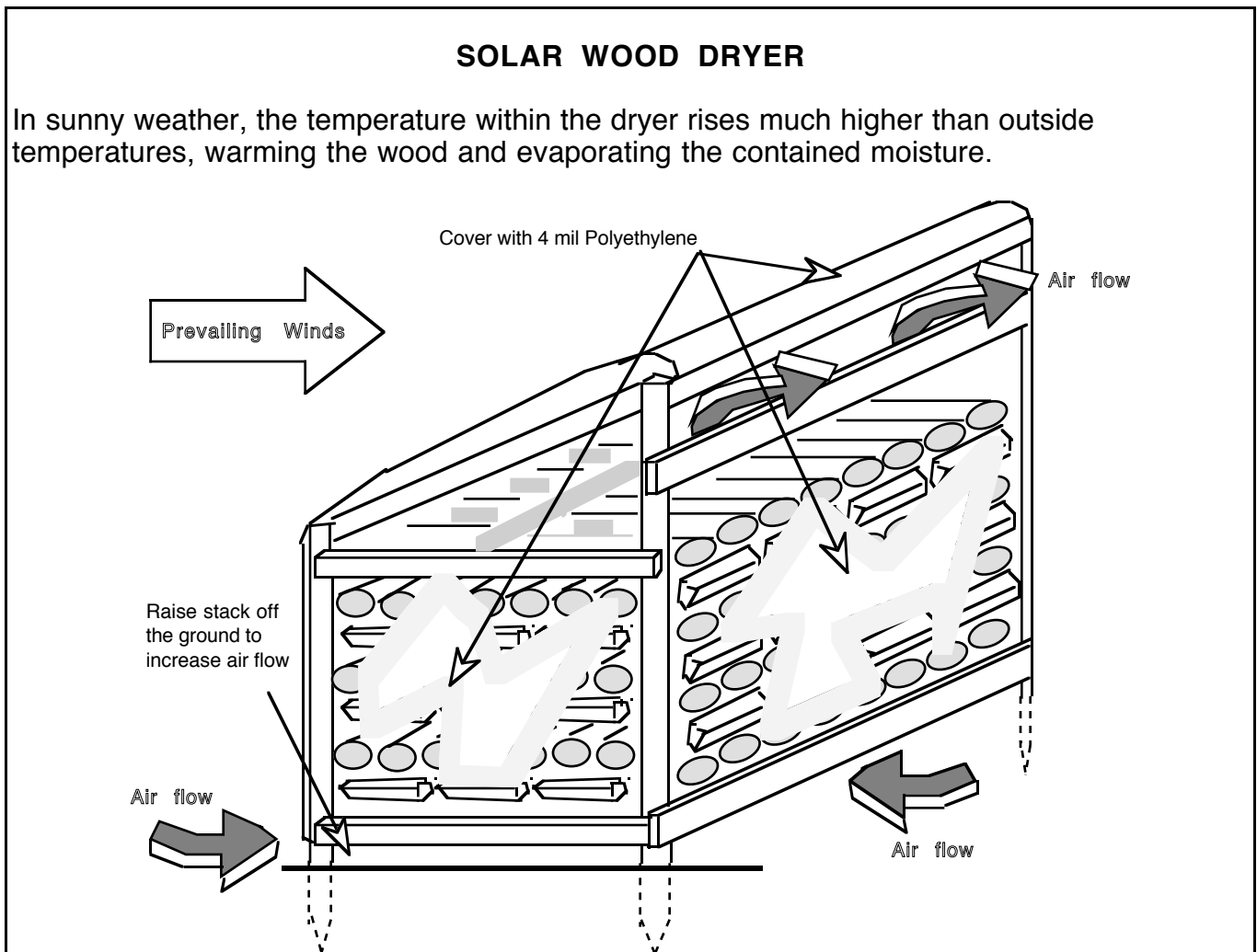

Many arrangements for plastic covering are possible. Thin 2 millimeter, clear polyethylene sheeting sold for drop cloths or garden mulching is not recommended because it is easily torn. The 4 millimeter thickness is more satisfactory and less costly than 6 millimeter. Any clear polyethylene deteriorates badly after a few months of exposure to full sunlight, so the stack may have to be re-roofed to remain dry over winter.

OPERATING YOUR APPLIANCE (Continued)

Seasoning Wood (Continued)

The bathroom scales can be used to check if firewood is still seasoning. Weigh a basket or bag of a few pieces of firewood. Place them back in the wood pile as an identified unit. Then weigh them again in about a month. If they have lost weight, the wood is still drying. Cracks that appear in the end of logs are good signs that the wood is well seasoned.

Generally, wood that is 1) cut to length, 2) split, and 3) stacked in the open, preferably with a cover, during the winter, should be thoroughly seasoned by the next heating season.

Storing Wood

Firewood is best stored outdoors, under cover and near the house so that valuable space in the house is not used, insects are kept outside, and the dirt problem is reduced. Store the wood under cover to keep it dry and its fuel value high. It can be stored in a wood shed, utility building, garage or under a sheet of plastic or sheet metal roofing.

When drying wood, the greater the surface area exposed to the air, the more rapid the drying. Wood greater than 8" in diameter or longer than 4' dries very slowly. Reduce the size of such sticks by splitting and/or sawing. Be sure to keep an air space between the wood and any covering. Stack the wood in loose piles that are raised off the ground. This will promote air circulation that helps dry the wood.

TYPICAL WOOD SHED

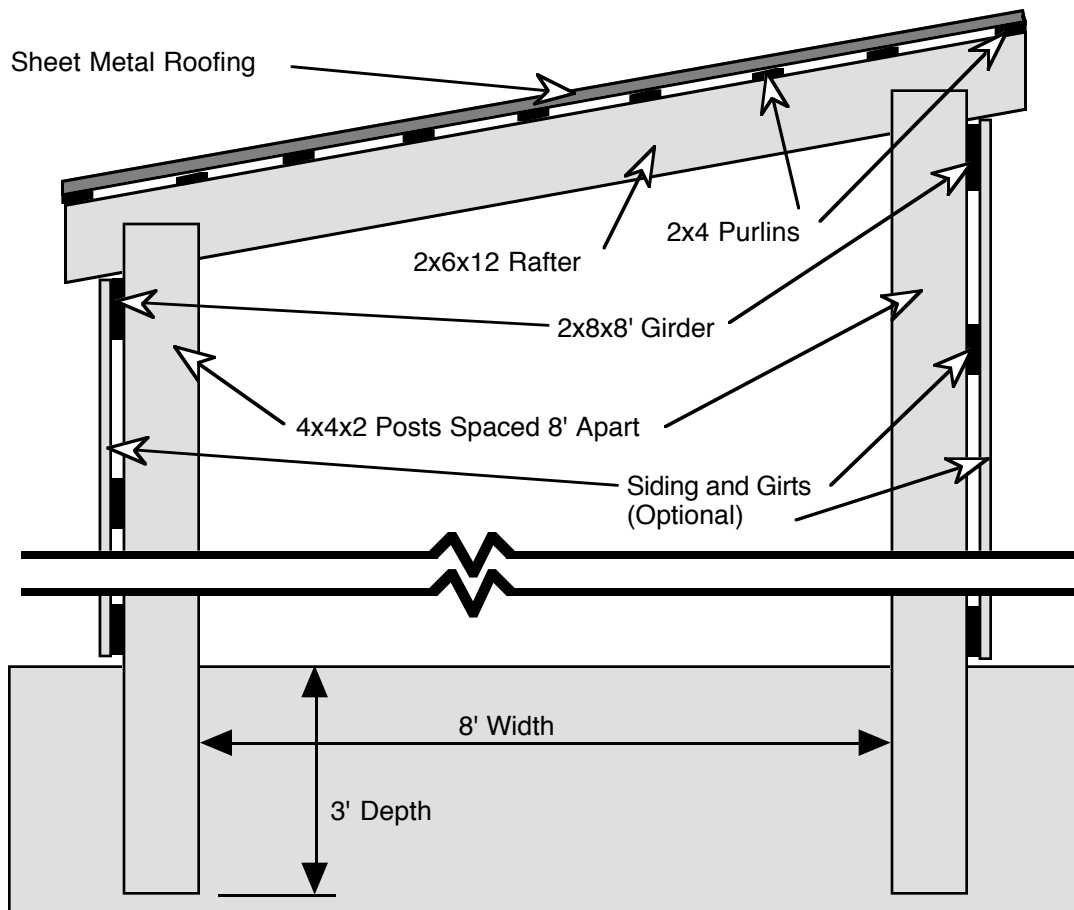

OPERATING YOUR APPLIANCE (Continued)

Storing Wood (Continued)

If sufficient space is available under a roof, seasoning and storage can be accomplished in one handling. This practice eliminates the extra handling of moving wood that has been dried outside into a covered storage area. Outside, wood will dry to between 14 and 25% moisture content depending on humidity, temperature, and wind. In a garage or woodshed it may dry to between 10 and 15% moisture content; and wood may dry to between 5 and 12% in the house.

End braces can be used if you have difficulty stacking wood and if the pile collapses at either end. Constructed with two-by-fours, end braces are like book ends and can be built to accurately measure a standard cord. The boards beneath the woodpile keep the bottom row off wet ground.

In some homes a wood box can be constructed inside the house, convenient to the wood appliance and which has loading access outside. The access door to the wood box from the outside of the house should be tight fitting.

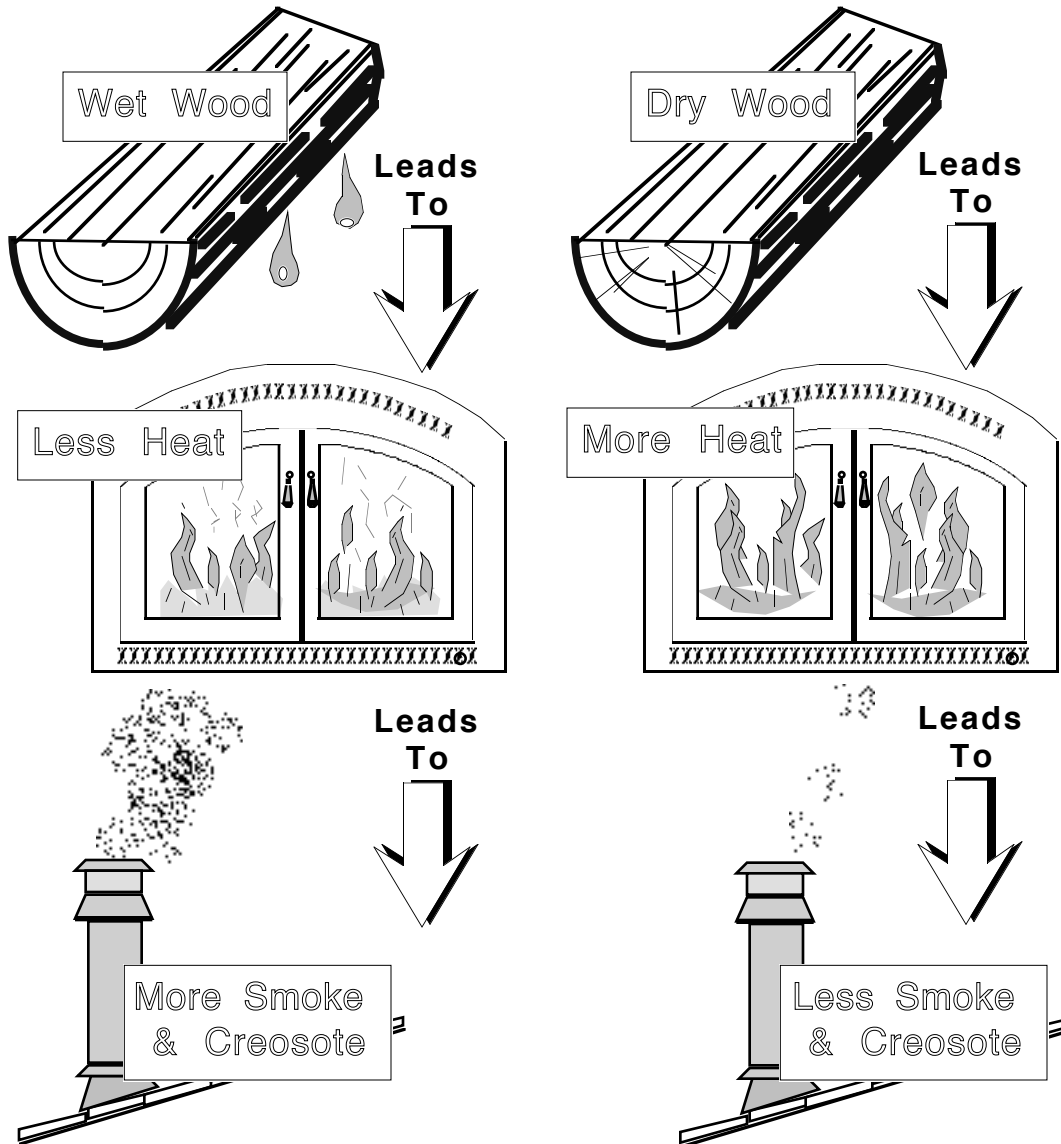

OPERATING YOUR APPLIANCE (Continued)

SAFETY IN OPERATION

The Following Safety Rules Should Be Followed Whenever Using Your Appliance:

- 1. Do not use this appliance for any purpose other than heating.**
- 2. Never use gasoline, gasoline-type lantern fuel, kerosene, engine oil, charcoal lighter fluid, or similar liquids to start or "freshen up" a fire. Keep all such liquids well away from the fireplace while it is in use.**
- 3. Do not burn garbage in your appliance, or use chemicals or fluids to start the fire.**
- 4. Use caution when loading fuel into the appliance after it is already burning vigorously.**
- 5. Do not over-fire the appliance at any time. If the appliance glows red, it is over-fired.**
- 6. Keep all household combustibles and appliance fuel at least 3 feet from the appliance at all times. Store fuel in a dry place well away from the appliance.**
- 7. Use only the grate provided with the appliance.**
- 8. Educate your children of the dangers associated with fire and the presence of a hot appliance. Touching a radiating surface can cause serious burns. Child guards are available through your dealer.**
- 9. Keep loading door closed at all times except to load fuel.**
- 10. Keep all wood and logs behind the log retainer. Avoid placing logs and fire against viewing glass.**
- 11. Maintain the door and glass seal and keep them in good condition.**
- 12. Do not modify your combustion air control to allow more air into your appliance.**
- 13. Do not burn any kind of coal in this appliance.**
- 14. Do not slam door or strike glass.**

CARE AND MAINTENANCE

Maintenance Schedule

The following schedule should be followed to insure your appliance stays in peak condition.

Weekly Maintenance: The following should be done once a week:

ASH DISPOSAL
CLEANING OF GOLD PLATED SURFACES
GLASS CLEANING

Bi-Monthly Maintenance: The following should be done every two months during the heating season:

DOOR AND WINDOW GASKET INSPECTION
LUBRICATE
DOOR LATCH INSPECTION AND ADJUSTMENT
CHECK FOR CREOSOTE

Yearly Maintenance: The following should be done after each heating season:

CATALYTIC COMBUSTOR INSPECTION & CLEANING
FIREBOX INSPECTION AND CLEANING
APPLIANCE TOUCH-UP
BLOWER CLEANING
CHIMNEY SYSTEM CLEANING

Maintenance Instructions

ASH DISPOSAL

During constant periods of use ashes must be periodically removed from the appliance to prevent a build-up which will affect the performance and limit the fuel load capacity. Ashes should be placed in a metal container with a tight fitting lid. The closed container of ashes should be stored on a non-combustible floor or on the ground, well away from any combustible material, pending final disposal. If the ashes are to be disposed of by burial in soil or otherwise locally dispersed, they should be retained in the closed container until all cinders have thoroughly cooled. Other waste must not be placed in this container.

CLEANING OF GOLD PLATED SURFACES

Gold is the very best material available for plating fireplace fronts, but it is not indestructible. The most common complaint with any plated surface on a wood burning appliance is discoloration. This can only be caused by heat and chemicals. The discoloration is permanent and cannot be removed without removing the gold plating. The following suggestions will help you keep the shine in your gold plating.

Keep plating free of dust and finger prints with DENATURED ALCOHOL applied with a very soft cloth. Do not use any other cleaners or polishes. Do not start a fire if there are finger prints or smudges on the gold plating, as they could become permanently etched in the gold plating. Make sure that the brick or stone is free of acid before installing the gold plating, consult your mason.



CARE AND MAINTENANCE (Continued)

GLASS CLEANING

Clean the glass only when the appliance is cool, using a non-abrasive cleaner. If the glass cracks or breaks, let the appliance cool before replacing it. **DO NOT OPERATE THE APPLIANCE WITH BROKEN OR MISSING GLASS. IF THE GLASS DOES BREAK, FOLLOW THE DIRECTIONS IN THE SECTION TITLED "REPLACEMENT PARTS AND REMOVAL INSTRUCTIONS" FOR REPLACING THE GLASS.**

DOOR AND WINDOW GASKET INSPECTION

A damaged or deteriorated window or door gasket will allow air to enter the appliance through the space between the door and firebox. This may allow smoke to enter the room and hamper efficient burning. Inspect the door gasket to make sure it is flexible and completely intact. Any torn or broken gaskets should be replaced by following the directions in the section titled "REPLACEMENT PARTS AND REMOVAL INSTRUCTIONS".

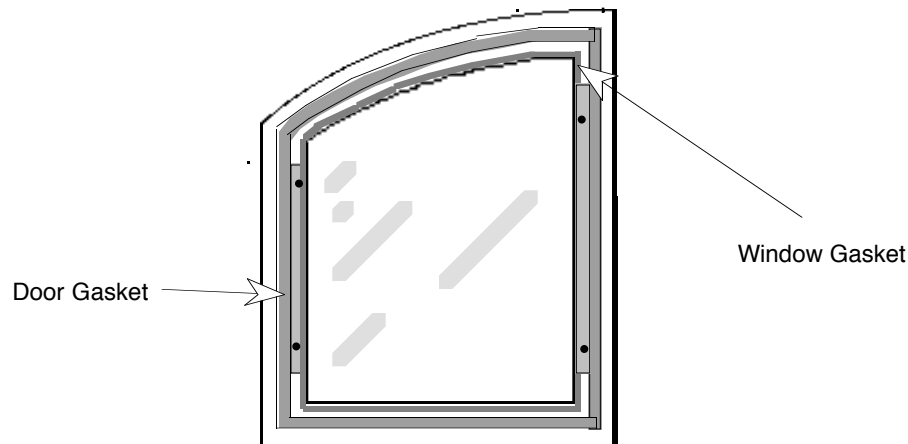

LUBRICATE

It is highly recommended that you periodically lubricate any moving parts such as the door hinges and combustion air control. This will eliminate any scraping or squeaking noises as well as allow the parts to move freely. A high temperature lubricant, such as Permatex Industrial (R) Anti-seize lubricant, is required. Graphite or low-temperature lubricants will only last a few days.

DOOR LATCH INSPECTION AND ADJUSTMENT

The door latch must be tested periodically to insure that a tight seal is being maintained between the door gasket and the fireplace. To test the door latch, close the fireplace door and secure the latch. Grasp the right side door handle and pull it back and forth. There should be approximately 1/16" of play. The handle should also be able to be turned all the way down. This movement is due to the door gasket compressing and expanding. If there is more than 1/16" of play, or if the door handle can not be turned down all the way, follow the directions in the following paragraphs to adjust the door.

The door latch is held onto the handle with two nuts (refer to the illustration on the following page). These nuts work in conjunction with three washers to space the latch the appropriate distance away from the door. The closer the latch is to the door, the tighter the latch will hold. The farther away from the door the latch is to the door, the more loose the latch will hold.

CARE AND MAINTENANCE (Continued)

If the door is too loose (it has more than 1/16" of play), the latch needs to be adjusted closer to the door (tightened). To do this, first remove the outer nut, the washer next to it, the latch, the inner nut, and the two washers next to the inner nut. Re-assemble the handle, putting only one of the washers between the door and the inner nut. The inner nut should only be tightened slightly, over-tightening will prevent the handle from turning. Put the other two washers between the latch and the nut farther away from the door. This will tighten the latch by approximately 1/16". To make minor adjustments, loosen the outer nut, then turn the inner nut until the desired distance is obtained. Then tighten the outer nut against the inner nut, making sure the inner nut does not turn by holding it in place with an open-end wrench.

If the door is too tight (the handle can not be turned down all the way), the latch needs to be adjusted away from the door. To do this, first remove the outer nut, the washer next to it, and the latch. Then loosen the inner nut approximately 1/2 turn. Re-assemble the items that were removed, making sure to line the latch up correctly with the flat side of the threaded shaft. Test the door to see if door handle can be turned down all the way. If it still needs adjustment, remove both of the nuts, the latch, and the washers. Re-assemble the handle, this time putting all three of the washers between the door and the inner nut. This will loosen the latch a significant amount. To make minor adjustments, loosen the outer nut, then turn the inner nut until the desired distance is obtained. Then tighten the outer nut against the inner nut, making sure the inner nut does not turn by holding it in place with an open-end wrench.

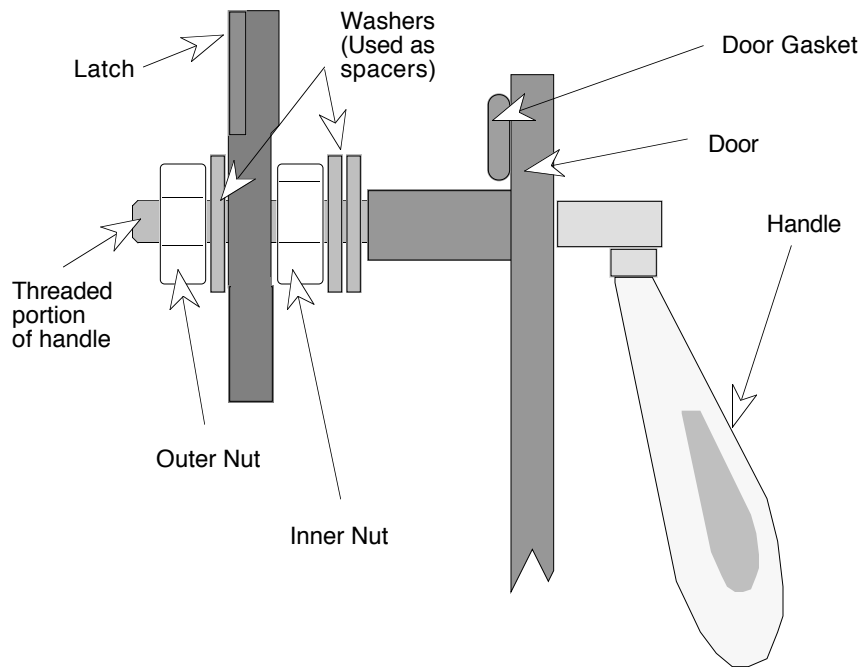

CHECK FOR CREOSOTE

Creosote is a tarry liquid or solid resulting from the distilling of wood during the combustion process. Using wet wood or burning at lower temperatures will result in a heavier creosote deposit. Creosote vapors will condense in a relatively cool chimney flue of a slow burning fire. As a result, creosote residue accumulates on the interior surface of the chimney and flue pipes, considerably reducing their diameter. When ignited, this creosote makes an extremely hot and dangerous fire. The chimney should be inspected at least once every 2 months during the heating season to determine if a creosote build-up of approximately 1/4" has accumulated. If this is the case, the creosote should be removed to reduce the risk of a chimney fire.

CARE AND MAINTENANCE (Continued)

CHECK FOR CREOSOTE (Continued)

Most problems with creosote are due to poor chimneys with low draft and/or cold chimney walls, and to a low rate of burn when little heat is needed during the spring and fall months. Burning green and wet wood also creates creosote.

To prevent creosote accumulation:

1. Burn your appliance with the combustion air control wide open for about 20-30 minutes daily during the burning season. This will burn out creosote deposits in your appliance.
2. Burn the appliance with the combustion air control wide open for about 20 minutes every time you apply fresh wood. This allows the wood to achieve the charcoal stage faster and burns the wood vapors which might otherwise be deposited within the system.
3. Burn only seasoned, dry wood. Seasoned wood is wood that has been dried for at least one year.
4. A small, more intense fire is preferable to a large smoldering one that will deposit creosote within the system.
5. Establish a routine for using your new appliance. Be aware that the hotter the fire, the less creosote is deposited on the glass and chimney system. Weekly inspection and cleaning may be necessary during times of heavy appliance usage. Contact your local fire authority for information on how to handle a chimney fire. Have a clearly understood plan to handle such a fire.
6. We recommend you have your chimney system and appliance checked and cleaned by a competent chimney sweep at least once a year.

CATALYTIC COMBUSTOR INSPECTION & CLEANING

It is important to periodically monitor the operation of the catalytic combustor to insure that it is functioning properly and to determine when it needs to be cleaned or replaced. A non-functioning combustor will result in a loss of heating efficiency and an increase in creosote and emissions. The following is a list of ways to monitor the catalytic combustor.

Visual Inspection & Cleaning Of The Catalytic Combustor

Combustors should be visually inspected before and after each heating season to determine if physical degradation has occurred. Removal of the mixing screen in front of the combustor is required for this inspection. Refer to the "REPLACEMENT PARTS AND REMOVAL INSTRUCTIONS" section of this owner's manual for removal instructions. Do not remove the catalyst from the combustor assembly unless it needs replacement because it is fragile. Check the combustor for plugging. If the front of the combustor and/or mixing screen is covered with a fine dust plugging some of the openings, either vacuum it or use a soft paint brush to brush off the dust. Check to see if the combustor is cracked, broken, or deteriorated. Replace the combustor if damaged (available at your dealer).

Periodic Inspection Of Catalytic Combustor Performance

To get an indication of whether the catalyst is working, compare the amount of smoke leaving the chimney when the smoke is being routed through the combustor to the amount of smoke leaving the chimney when the smoke is not routed through the combustor (by-pass open

CARE AND MAINTENANCE (Continued)

CATALYTIC COMBUSTOR INSPECTION & CLEANING (Continued)

mode). Use the following three steps to determine your catalytic combustor's performance:

- Step 1. Light fireplace. Let the fireplace reach operating temperature.
- Step 2. With smoke routed through the catalyst (By-pass closed), go outside and observe the emissions leaving the chimney.
- Step 3. Open the by-pass and again observe the emissions leaving the chimney. You should see significantly more smoke when the exhaust is not routed through the combustor (by-pass mode). Be careful not to confuse smoke with steam from wet wood.

If you can't operate with combustor temperatures in excess of 500 degrees F. there will be excessive smoke leaving the chimney. You should check to make sure that your firewood is dry and seasoned. Wet or green wood will cause the combustor to not light off until the moisture is evaporated. Because the combustor is not working under these conditions, excessive amounts of creosote can be deposited in the chimney system.

Using A Temperature Probe To Check The Catalytic Combustor

Visual inspection of the catalytic combustor should provide a suitable method for monitoring this component in your fireplace. If a more detailed monitoring process is desired, a temperature probe can be used to monitor the fireplace while it is in operation.

Your Fireplace Xtordinair is equipped with a hook-up for a temperature probe to monitor combustor operation. There is a two prong connector plug behind the blower speed control for a Condar Temp-meter (Model 9-85). To attach the Temp-meter, attach a matching connector plug or splice the wires coming from the Temp-meter to the two prong connector plug behind the blower speed control. A properly functioning combustor typically maintains temperatures in excess of 500 to 1000 degrees F. If combustor temperatures are not in excess of 500 degrees F. refer to the section "Visual Inspection & Cleaning Of The Catalytic Combustor" in this owner's manual to determine the problem.

FIREBOX INSPECTION AND CLEANING

At the end of each heating season, remove all of the ash inside the firebox and check for any scale that may have built up during the heating season. Remove any scale from the inside of the firebox with a wire brush or scraper. With a flashlight check to see that all of the firebrick lining the firebox is in good condition. If any of the firebrick is cracked or broken, follow the directions in the section titled "REPLACEMENT PARTS AND REMOVAL INSTRUCTIONS" for removal and replacement of any damaged firebrick.

APPLIANCE TOUCH-UP

The outside of the appliance can be touched up using high temperature "Forrest Stove-Brite" paint, available at your dealer. This will improve the looks of your appliance, but is not necessary. To touch up paint, first sand the area to be painted with 120 grit sandpaper, clean it with water only, and dry with a clean cloth. Paint using light covering coats. The newly painted area will appear darker until the paint goes through the curing process.



CARE AND MAINTENANCE (Continued)

CHIMNEY SYSTEM CLEANING

We recommend you have your chimney system and appliance checked and cleaned by a competent chimney sweep at least once a year.

The chimney should be fully sealed and securely attached.

The chimney termination should be free of all blockage (ash, leaves, etc.)

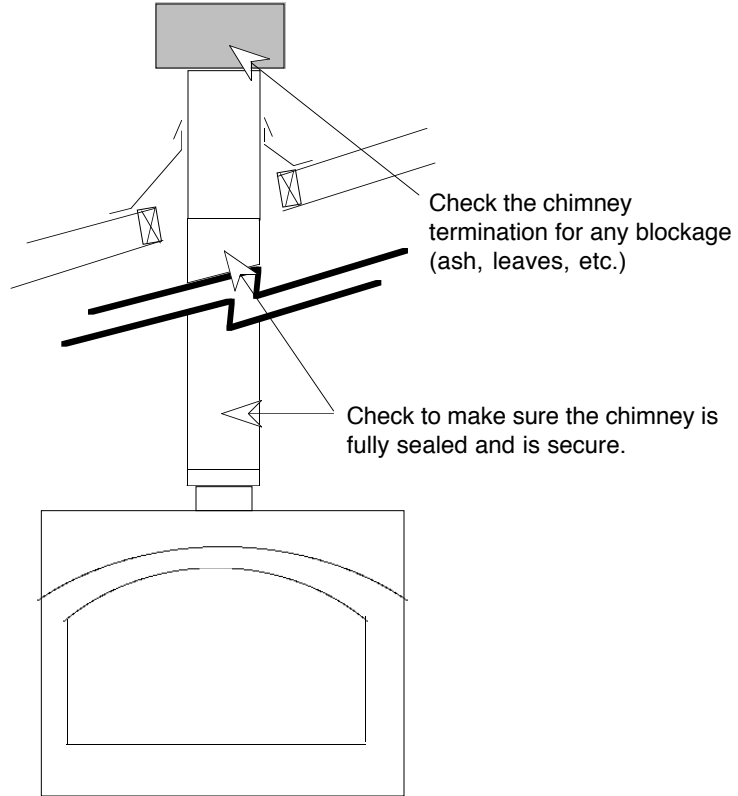

Blower Cleaning

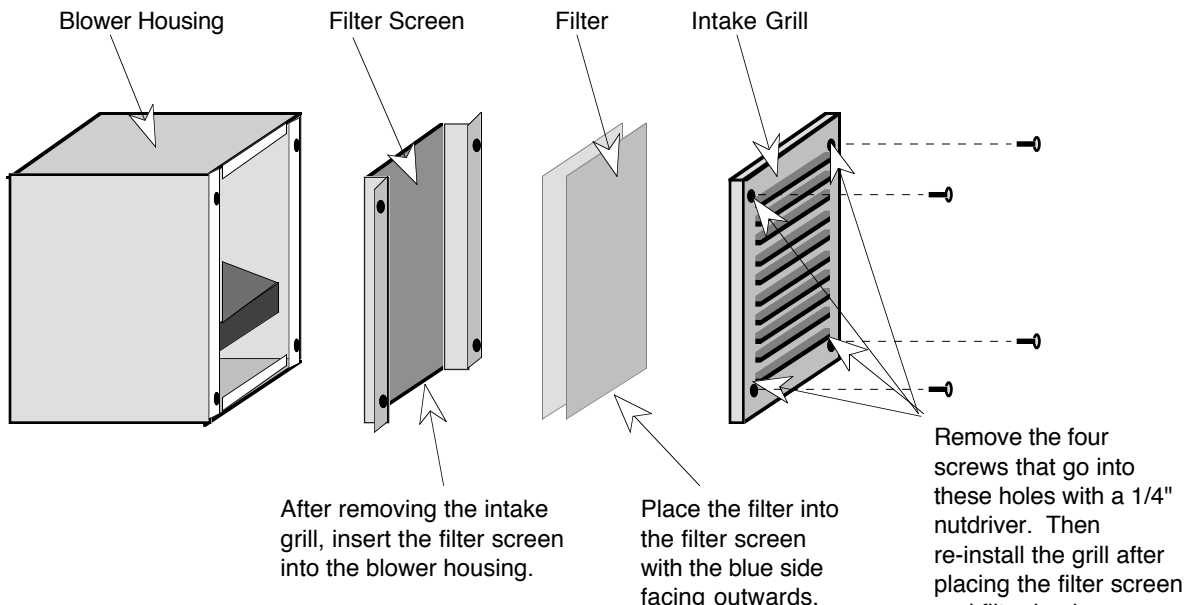

Every year the blower should be cleaned of any dirt or dust that may have accumulated. The blower housing on your Fireplace Xtrordinair is a separate unit located away from the fireplace. Locate the intake grill that fits over the blower housing and remove the four screws that hold the grill in place with a 1/4" nutdriver. Remove both the filter and filter screen. Vacuum out any dirt or dust that may have accumulated inside the blower housing. Shake the filter and filter holder to remove any dirt or dust that may have accumulated. Replace the filter screen, filter (blue side facing the intake grill), and intake grill and re-attach with the four screws removed. See the illustration below.



BEFORE CALLING FOR SERVICE

SAVE TIME AND MONEY - CHECK THIS LIST BEFORE YOU CALL FOR SERVICE

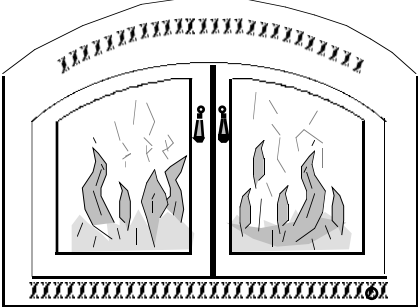
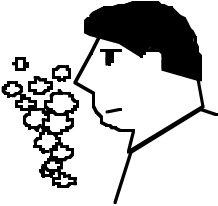
To eliminate unnecessary service calls, first read all the instructions in this manual carefully. The following checklist provides possible solutions to common occurrences that are **not** the result of defective workmanship or materials in this appliance. If you do have a problem that you cannot fix yourself, call the dealer where you purchased your appliance. When calling, have this manual handy with the model, serial number and purchase date of your appliance.

Problem	Possible Cause	Don't Call for Service Until You Check
<p><u>Start-up fire extinguishes itself.</u></p>	<ul style="list-style-type: none"> • Combustion air control closed. • Wet wood. 	<ul style="list-style-type: none"> • Combustion air control is open. • Wood is dry & seasoned.
<p><u>Fire sluggish or lazy.</u></p> 	<ul style="list-style-type: none"> • Bad Fuel. • Restricted Flue. • Poor Draft. • Combustor plugged with flyash. 	<ul style="list-style-type: none"> • Wood is dry & seasoned. • Chimney is clean & unrestricted. • Sufficient chimney length & correct size. • Combustor is not clogged – vacuum or brush with a soft brush.
<p><u>Smoke smell inside house.</u></p> 	<ul style="list-style-type: none"> • Restricted chimney or down draft. • Air leak from faulty door or glass gasket. • Door is out of adjustment. 	<ul style="list-style-type: none"> • Chimney is clean & unrestricted. • Chimney is not receiving a down draft due to wind or other obstruction. • Door and glass gasket are in good condition and sealing properly. • Door is aligned with the opening so the door gasket makes an airtight fit around the opening.
<p><u>Appliance won't shut down to a low burn rate.</u></p> 	<ul style="list-style-type: none"> • Air leak from faulty door or glass gasket. • Door is out of alignment. 	<ul style="list-style-type: none"> • Door and glass gasket are in good condition and sealing properly. • Door is aligned with the opening so the door gasket makes an airtight fit around the opening.

REPLACEMENT PARTS AND REMOVAL INSTRUCTIONS

Several components inside your appliance are serviceable by you. These components are usually easy to remove and replace without special tools. Before you attempt to carry out any of these steps, be sure to read through the entire section. To order new parts, use the chart below to order the appropriate part number through your dealer. Use only parts from your dealer made specifically for your appliance.

Replacement Parts

Part Name	Part Number	Part Description
Door Gasket (includes adhesive)	92-7350	5/8" x 1/16" White Gasket
Door Glass (includes gasket)	92-7375	Lined with black gasket
Door Handle	92-7300	Phenolic
Firebrick (note size)	See Removal and Replacement Instructions.	4 1/2" x 9" x 1 1/4" Un-Cut
Catalytic Combustor	92-7400	See Below
By-Pass Damper Knob (with set screw)	92-7270	Gold Plated
Owner's Manual	92-7500	This Manual
Glass Clip	92-7380	Holds Glass in Place
Installation Manual	92-7510	Included with Fireplace
Blower Filter	92-7444	Filters Dirt Particles

Catalytic Combustor Replacement Information

The catalytic combustor supplied with this appliance is a Corning, Inc. Model 3.5 X 14.5 X 2-16, cell density = 16 per square inch. Consult the combustor warranty supplied with this appliance. Warranty claims for the combustor should be addressed to:

Corning, Incorporated
Technical Products Division
Corning, New York 14831
(607) 974-9000

If you have any warranty questions concerning your combustor please direct your questions to Corning, Inc. You will be given information about how to package and return your combustor.

Removal Instructions

The remaining text in this section details the items below. Make sure to follow the directions closely when performing one of the procedures. If re-assembly directions are not given with the instructions, re-assemble by following the directions in reverse order. All of these procedures can be done without special tools.

- Removing and Replacing the Glass
- Removing and Replacing the Door Gasket
- Removing and Replacing the Firebricks
- Removing and Replacing the Catalytic Combustor
- Removing and Replacing the Blower Filter

REPLACEMENT PARTS AND REMOVAL INSTRUCTIONS (Continued)

Removing and Replacing the Glass

DO NOT OPERATE THE APPLIANCE WITH BROKEN OR MISSING GLASS. IF THE GLASS DOES BREAK, FOLLOW THE DIRECTIONS BELOW TO REPLACE THE GLASS.

To remove the glass, simply remove the two glass clips on the back of the door by removing the two phillip-head screws that hold each glass clip in place. The glass, with gasket attached, can then be slid up and away from the "U" shaped retainer. The replacement glass comes with the gasket attached. Use only Travis Industries glass, which is made specifically for this model (available from your dealer). Place the glass in position, line up one of the glass clips in front of the holes in the retainer, and tighten the two phillip-head screws. Repeat for the other glass clip. The clips should clamp against the glass gasket, not the glass. Tighten the screws until the clips are firmly against the glass gasket, making an airtight seal.

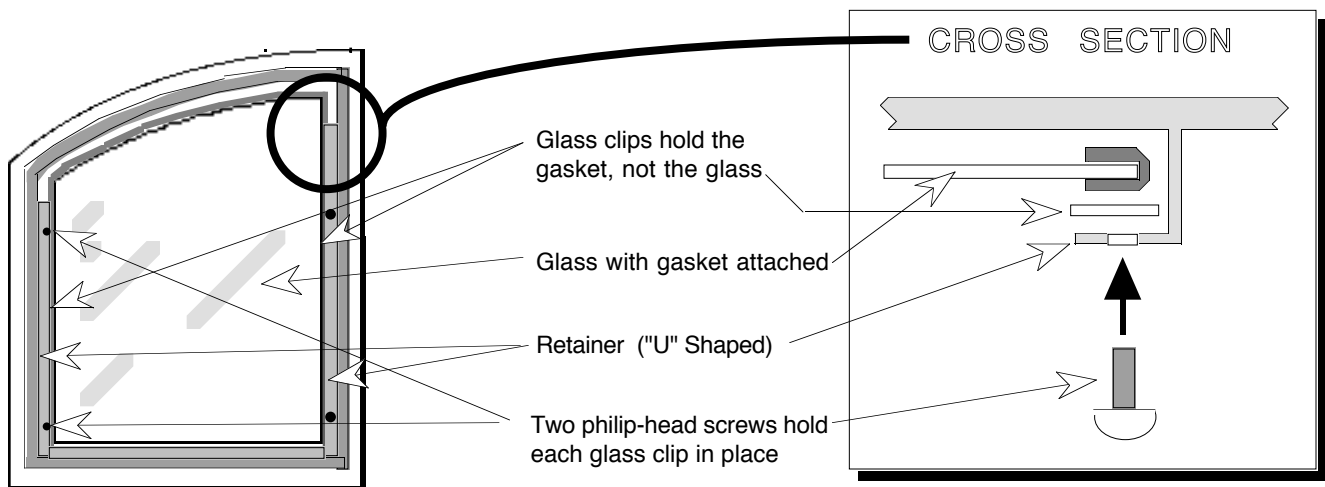

Removing and Replacing the Door Gasket

A damaged or deteriorated door gasket will allow air to enter the appliance through the space between the door and firebox. This will allow smoke to enter the room and hamper efficient burning. The door gasket is held in place with special cement made to withstand extreme heat. To remove the gasket, carefully pull the gasket away from the door and scrape any excess cement off the door (Note its position). To replace, use the manufacturer's gasket and cement (provided by your dealer) and re-attach the gasket, making sure it is aligned in the same way as the original.

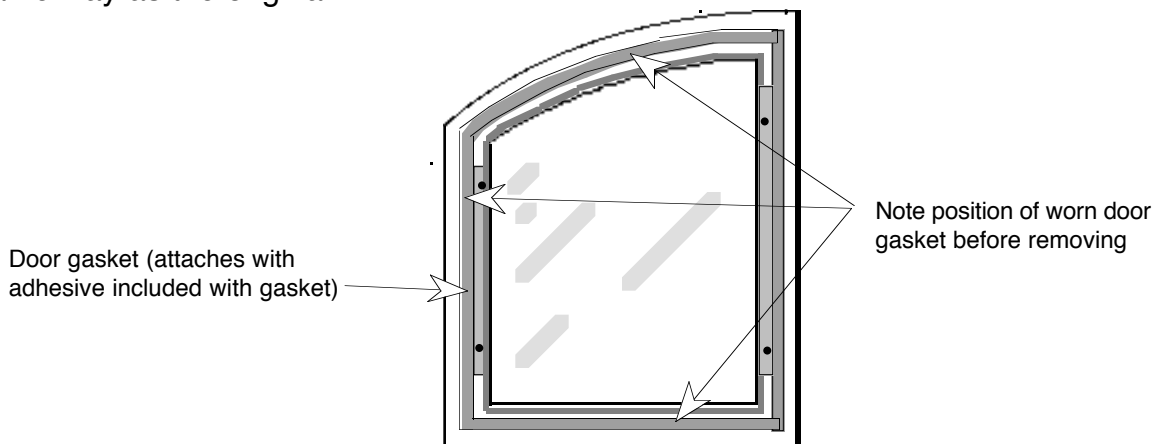

REPLACEMENT PARTS AND REMOVAL INSTRUCTIONS (Continued)

Removing and Replacing the Firebricks

The firebricks inside your wood-burning appliance are used to store the radiating heat and create a more thorough combustion inside the firebox. Occasionally one of them will crack and require replacement. Before any bricks are removed, make sure the appliance is cool and cleaned out. When replacing a specific firebrick, follow the directions below for removing the firebricks. Once the broken firebrick is removed, it can be replaced and the firebricks that have been removed can be replaced by following the previous directions in reverse order. There is no need to remove all of the firebricks when replacing just one firebrick. The only time all of the firebricks should be removed is when the appliance needs to be lightened or when the firebox is being cleaned thoroughly.

REMOVING THE SIDE FIREBRICKS

1. Make sure the appliance is cool and cleaned out.
2. Remove the doors by opening each one 90 degrees and pulling it upwards. Make sure to grasp the door by both ends. It is heavy and can be damaged easily.
3. Remove the side firebricks in the order listed below. The side firebricks are held in place by metal clips that attach to the side of the firebox. Grasp the bricks, one at a time, from the bottom and pivot them out from the bottom.

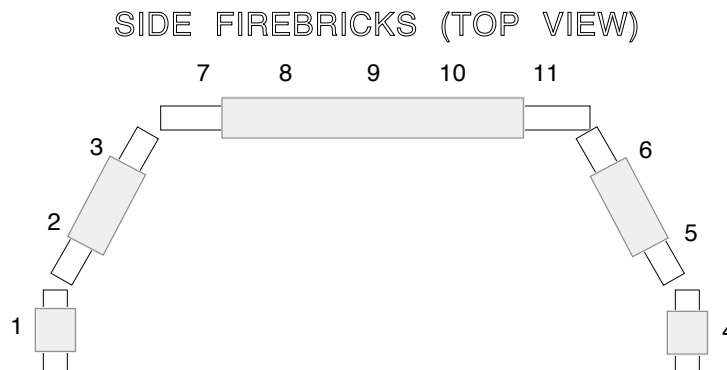

4. When replacing any of the side firebricks, use firebrick available from your dealer. The dimensions of the side firebricks are 1 1/4" thick, 4 1/2" wide, and 9" long. The left side firebrick located in front (Brick #1) has a hole drilled in it for gas line installation. If this firebrick is damaged and needs to be replaced, make sure to specify this when ordering a replacement firebrick.

REMOVING THE BOTTOM FIREBRICKS

1. Make sure the appliance is cool and cleaned out.
2. Remove the doors by opening each one 90 degrees and pulling it upwards. Make sure to grasp the door by both ends. It is heavy and can be damaged.
3. Remove the side firebricks, following the directions listed above.

REPLACEMENT PARTS AND REMOVAL INSTRUCTIONS (Continued)

Removing and Replacing the Firebricks (Continued)

REMOVING THE BOTTOM FIREBRICKS

4. Remove the bottom firebricks in the order listed to the right. Note the position of each firebrick as they are being removed from the firebox. Certain firebricks have unique dimensions which require that their relative position is correct when they are replaced.

BOTTOM FIREBRICK (TOP VIEW)

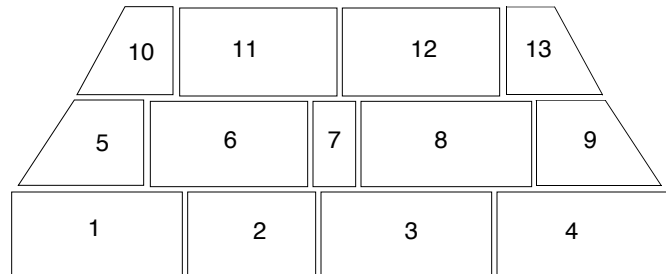

5. When replacing any of the bottom firebricks, use firebrick available from your dealer. Every bottom firebrick is 1 1/4" thick. The other dimensions vary depending upon the firebrick being replaced. Use the chart below in conjunction with the illustration above to determine the dimensions of the firebrick to be replaced.

Dimensions of Firebrick

Brick # 1,3,4,6,8,11,12	2	7	5,9	10,13

Removing and Replacing the Blower Filter

The blower filter is designed to prevent dirt particles and insects from being drawn into the blower and blown through the fireplace. Refer to the illustration below when replacing the filter.

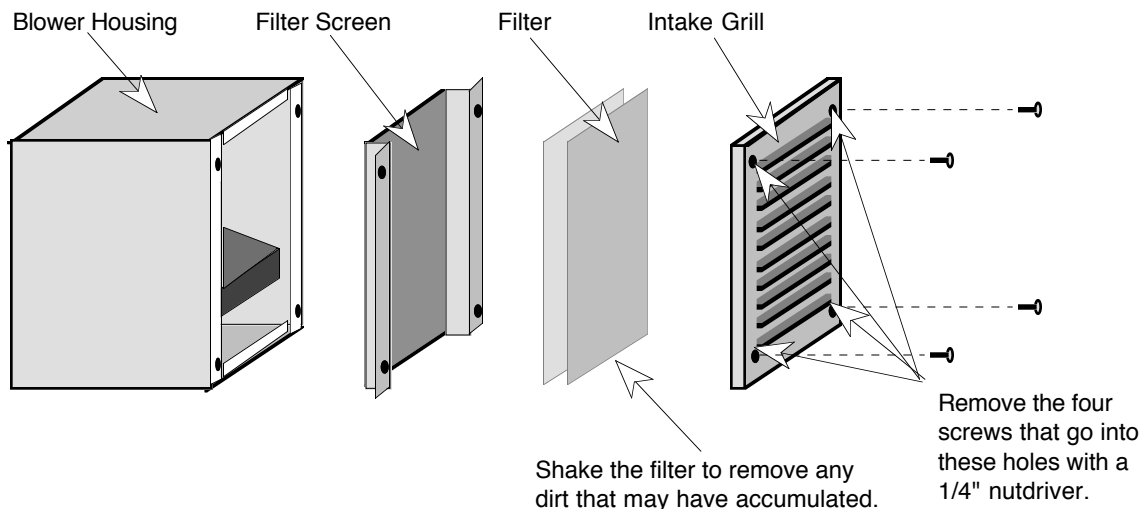

REPLACEMENT PARTS AND REMOVAL INSTRUCTIONS (Continued)

Removing and Replacing the Catalytic Combustor

Before replacing the catalytic combustor, make sure it is inoperable by conducting the steps for testing the catalytic combustor in the section "CARE & MAINTENANCE". The catalytic combustor is fragile, and should not be removed unless being replaced. Before attempting to remove the catalytic combustor, allow the fireplace to sit for approximately 24 hours without a fire.

1. Using a 9/16" wrench or socket wrench, remove the 7 bolts holding the steel plate in place on the top inside of the firebox. This is the holder of the catalytic combustor.

2. Pull the combustor up slowly and carefully from the holder. The gasket around the combustor will come apart and need to be replaced. This can be obtained from your Fireplace Xtordinaire dealer.

3. To reinstall the combustor, clean the holder, wrap the combustor with new Interram gasket and carefully slide it into the holder. Put the holder back in place and tighten the bolts. Fireplace Xtordinaire suggest that a high temperature anti-seize lubricant be applied to the bolts before they are put in to prevent seizing.

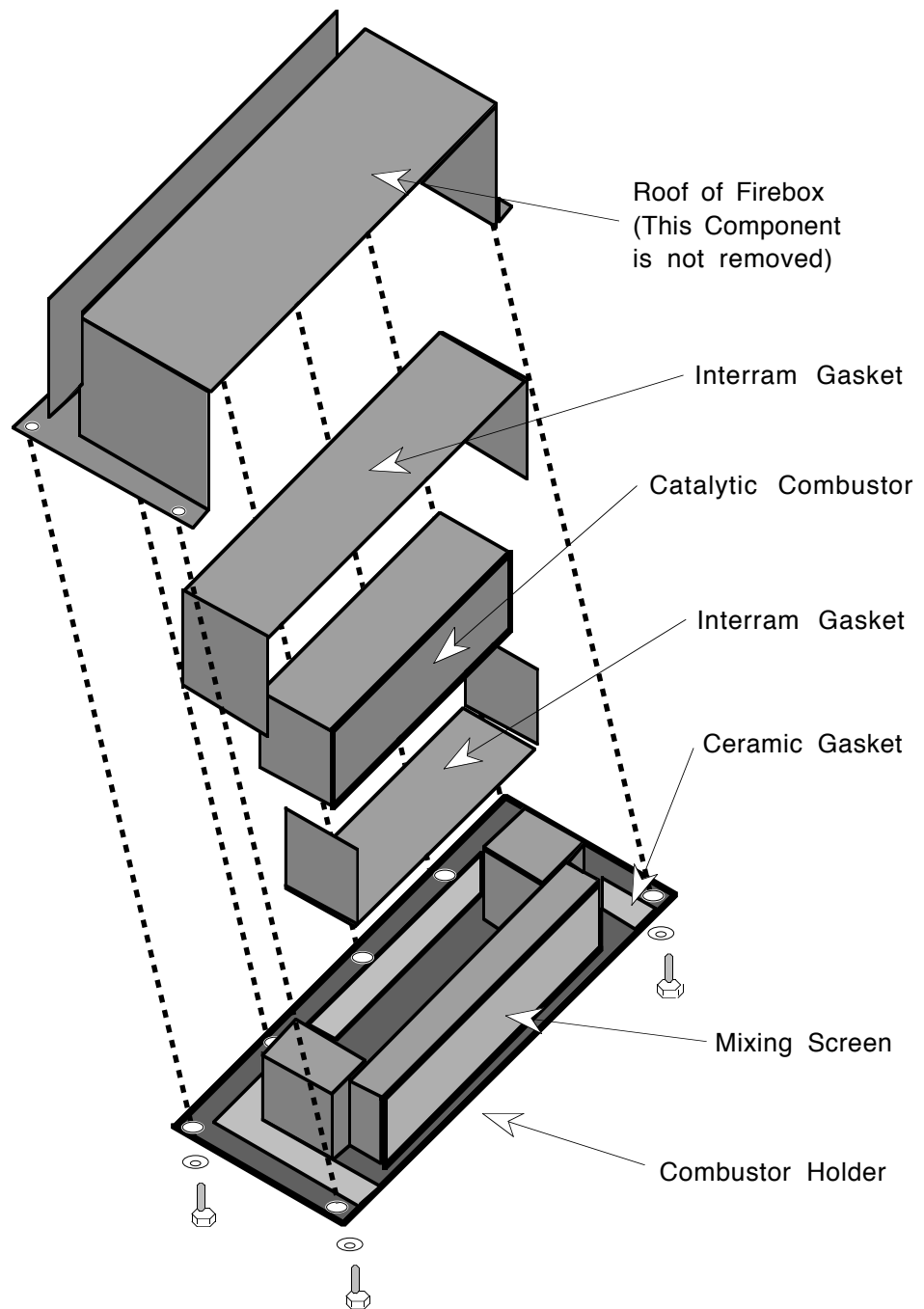

5-YEAR WARRANTY

TRAVIS INDUSTRIES, INC. warrants the **FIREPLACE XTRODINAIR** appliance to be defect-free in material and workmanship for five (5) years from the date of purchase, with the exception of the glass, gold plating, paint, brick, refractory, removable baffle parts and blowers. The blowers and removable baffle parts are warranted for one (1) year from the date of purchase to be defect - free in material and workmanship. The glass, paint, bricks, gold plating, and refractory are not warranted.

Exclusions to this limited warranty include: Injury, malfunction to the product, loss, damage, defect, failure to function due to accident, negligence, misuse, improper installation, alteration or adjustment of the manufacturer's settings of components, lack of proper and regular maintenance, damage incurred while the appliance is in transit, alteration, or act of God.

This limited warranty excludes damage caused by normal wear and tear, such as paint discoloration or chipping, worn or torn gasketing, eroded or cracked refractory, etc. Also excluded is damage to the appliance caused by abuse, improper installation, the use of fuel or fuel loads other than specified by the manufacturer or use not set forth in the Owner's Manual. An over-fired condition will cause warped metal parts and discolored or burned-off paint.

TRAVIS INDUSTRIES, INC. is free of liability for any damages caused by the appliance, as well as inconvenience expenses, material and labor charges incurred by the removal or reinstallation of any **FIREPLACE XTRODINAIR** appliance. Incidental or consequential damages are not covered by this warranty. In some states, the exclusion of incidental or consequential damage may not apply.

This warranty does not cover any loss or damage incurred by the use or removal of any component or apparatus to or from the **FIREPLACE XTRODINAIR** appliance.

Any statement or representation of **FIREPLACE XTRODINAIR** products and their performance contained in **FIREPLACE XTRODINAIR** advertising, packaging literature, or printed material is not part of this limited warranty.

This warranty is automatically voided if the appliance's serial number has been removed or altered in any way.

Only the original purchaser of an **FIREPLACE XTRODINAIR** appliance is covered by this warranty. If the appliance is used for commercial purposes, it is excluded from this warranty.

No dealer, distributor, or similar person has the authority to represent or warrant **FIREPLACE XTRODINAIR** products beyond the terms contained within this warranty. TRAVIS INDUSTRIES, INC. assumes no liability for such warranties or representations.

THIS LIMITED WARRANTY IS THE ONLY WARRANTY SUPPLIED BY TRAVIS INDUSTRIES, INC., THE MANUFACTURER OF THE APPLIANCES. ALL OTHER WARRANTIES, WHETHER EXPRESS OR IMPLIED, ARE HEREBY EXPRESSLY DISCLAIMED AND PURCHASER'S RECOURSE IS EXPRESSLY LIMITED TO THE WARRANTIES SET FORTH HEREIN.

This warranty is limited to the time frame set forth above. In some states, time limitations on warranties do not apply.

HOW TO USE YOUR TRAVIS INDUSTRIES, INC. FIVE-YEAR WARRANTY: If you find your appliance to be defective in workmanship or material within a 5-year period from the date of purchase contact your local authorized **FIREPLACE XTRODINAIR** dealer. If your dealer is unable to repair your appliance's defect, you may process a warranty claim through TRAVIS INDUSTRIES, INC., including the name of the dealership where you purchased the appliance, a copy of your receipt showing the date of the appliance's purchase, and the serial number on your appliance. At that time, you will be directed by TRAVIS INDUSTRIES, INC. on what course of action to take. TRAVIS INDUSTRIES, INC., at its option, will repair or replace any defective part on your **FIREPLACE XTRODINAIR** appliance if it is found to be defective in material or workmanship within the time frame stated within this limited warranty.

To register your TRAVIS INDUSTRIES, INC. Five-Year Warranty, complete the enclosed warranty card and mail it within ten (10) days of the appliance purchase date to: TRAVIS INDUSTRIES, INC., 10850 117th Place N.E., Kirkland, WA 98033.

OTHER RIGHTS:

This warranty provides you with certain legal rights. You may have additional rights, which vary from state to state, in regards to this warranty.

APPLIANCE SERIAL NUMBER _____
DATE OF PURCHASE _____
DEALER NAME AND ADDRESS _____

**Complete
and save
for your
records**

Travis Industries, Inc. reserves the right to change, without notice, product features or specifications described.



