

OWNER'S INSTALLATION AND OPERATION INSTRUCTION BOOK

Blaze[®] King

WOOD STOVES

BLAZE KING, Princess catalyst model, Top Vent
PE-1000 and PEJ-1000

MANUFACTURED UNDER LICENSEE AGREEMENT

FROM: WOODCUTTERS MFG., INC.
Route 4, Box 218
Walla Walla, WA 99362

BY:

OM-9

11/09/82
RCR

**BLAZE PRINCESS CATALYST STOVES
THE LATEST ADDITION TO THE BLAZE KING ROYAL FAMILY
INSTALLATION AND OPERATION INSTRUCTIONS**

You are now the proud owner of a Blaze Princess Catalyst stove—the finest, most beautiful stove ever introduced in America.

The Blaze Princess Catalyst stove is the first catalyst equipped stove made in the Royal Family.

The Blaze Princess Catalyst stove is clean and efficient. You'll be happy you own one.

It is the desire of Woodcutters Mfg., Inc. that your stove give you a lifetime of trouble-free operation. We suggest that before starting installation, you read these installation and operation instructions.

WARRANTY

To register your warranty, fill out and return the 'Warranty Card' packed with these instructions in the firebox of the stove.

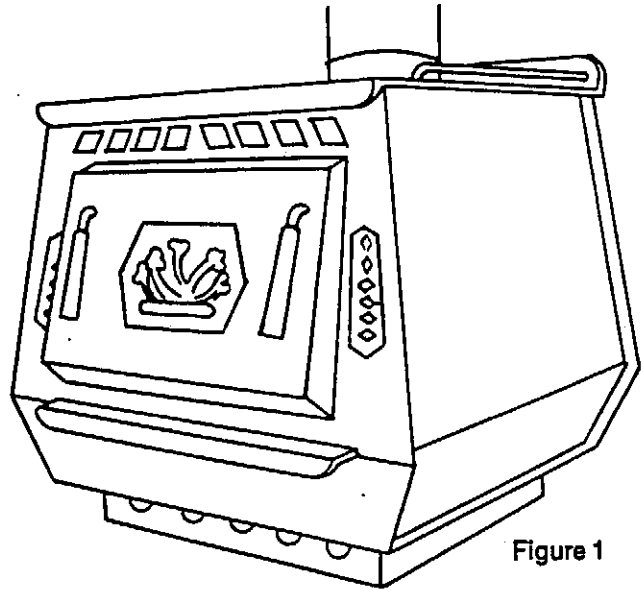

Figure 1

DIMENSIONS

Model	Width	Depth	Height	Weight (lbs.)
Blaze Princess PE-1000	26"	30"	29"	245
PEJ-1000	26"	33"	29"	260

PRODUCT INSPECTION

First, remove all packaged parts from your stove and inspect them. Make sure that the stove is complete. Examine the pieces to see that there is no damage caused by shipping. Should any part be missing or damaged, contact your dealer.

CHECK LIST

1. Stove with firebrick installed.
2. Doors with gasket material installed.
3. Wood handles.
4. Blower motor and screws.
5. Thermostat knob.
6. Ceramics (Figure 2)
7. Combustor



Figure 2

IMPORTANT

Improper installation of your Blaze Princess Catalyst stove, or failure to operate it according to the guidelines detailed in these instructions, may negate your warranty and endanger your home and family.

For years of carefree, efficient home heating, follow building and fire codes during installation and consult these instructions when operating your Blaze Princess Catalyst stove.

SOME CAUTIONS

1. Stove must be vented **ONLY** to the outside, not to other rooms or buildings.
2. **NEVER** use a chimney or chimney connector smaller than the 8" stove exhaust.
3. **NEVER** vent your coal burning stove into a 'Class B' gas vent chimney. Check with local authorities to make sure that you are not doing so inadvertently if you are using an existing chimney.
4. **DO NOT CONNECT THIS UNIT TO A CHIMNEY SERVING ANOTHER APPLIANCE.**
5. Burn natural wood **ONLY**. Burning materials other than natural wood will appreciably shorten the life of the Catalytic Combustor. **DO NOT** burn trash, garbage, artificial or paper logs, gift wrappings, coal, lighter fluids, chemical cleaners, chemical starters, treated or painted wood, driftwood, or foil backed paper such as gum wrappers or cigarette packages.

BUILDING CODES AND PERMITS

Some areas may require a permit from the city, county, Building Inspector, or Fire Marshal. Check local building codes before beginning installation. After the installation is completed, it should be checked by your local Fire Marshal or Building Inspector.

SELECTION OF STOVE LOCATION

Underwriters Laboratories, Inc. listed this appliance only to be connected to suitable masonry chimney or an 8", listed, low heat, prefabricated, metal chimney system and minimum clearances to combustibles are observed. See CHIMNEYS and CHIMNEY CONNECTORS.

WARNING: DO NOT cut ceiling or roof joists without maintaining the structural support of the dwelling.
DO check floor joists for proper support of the stove.

PLACEMENT: See Fig. 3, 4, 5 and 6

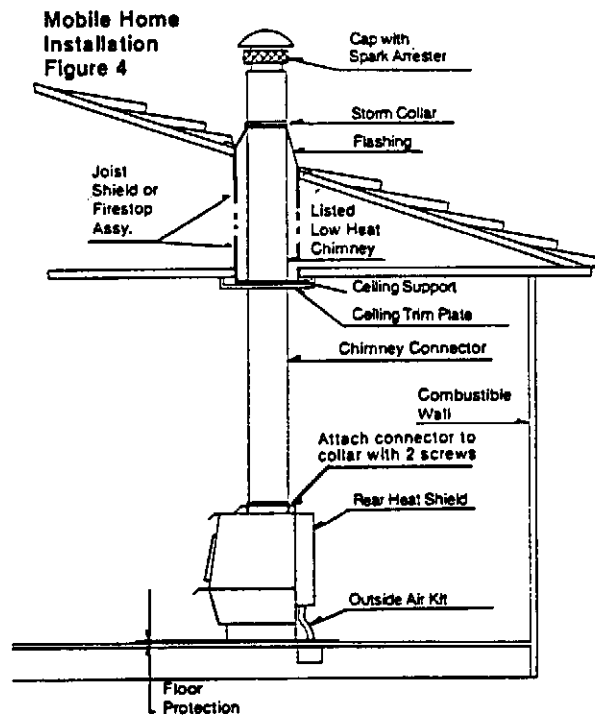
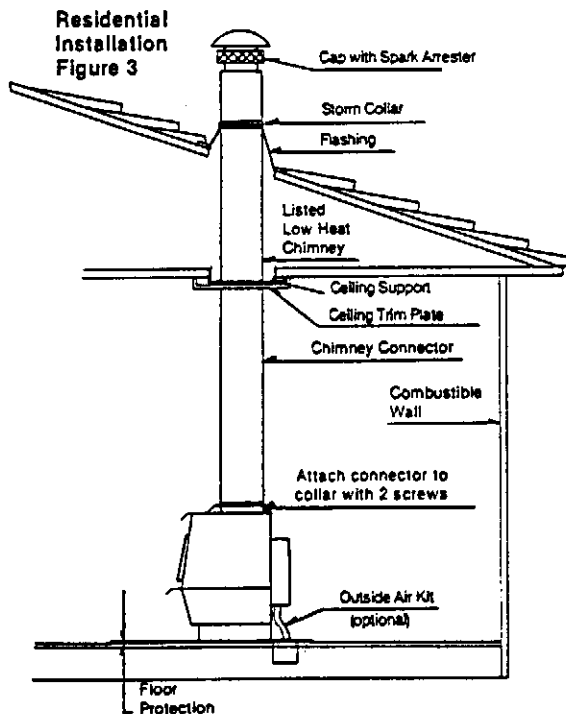

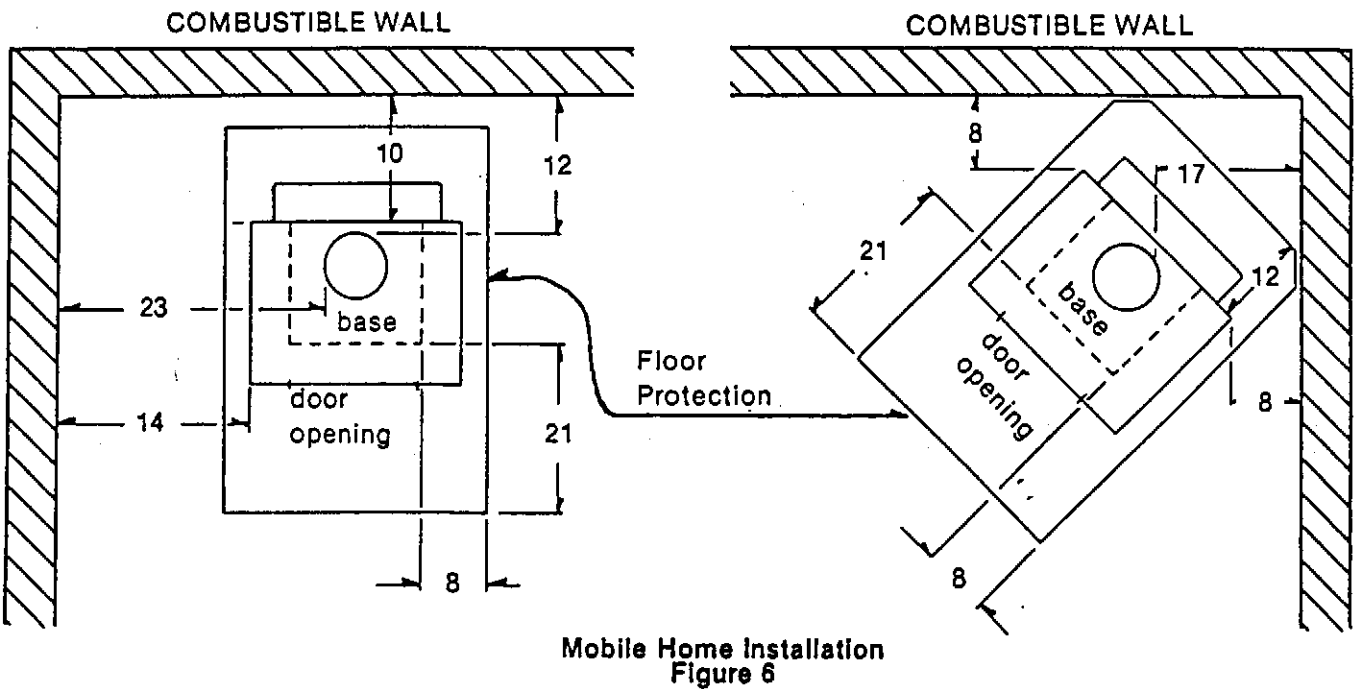
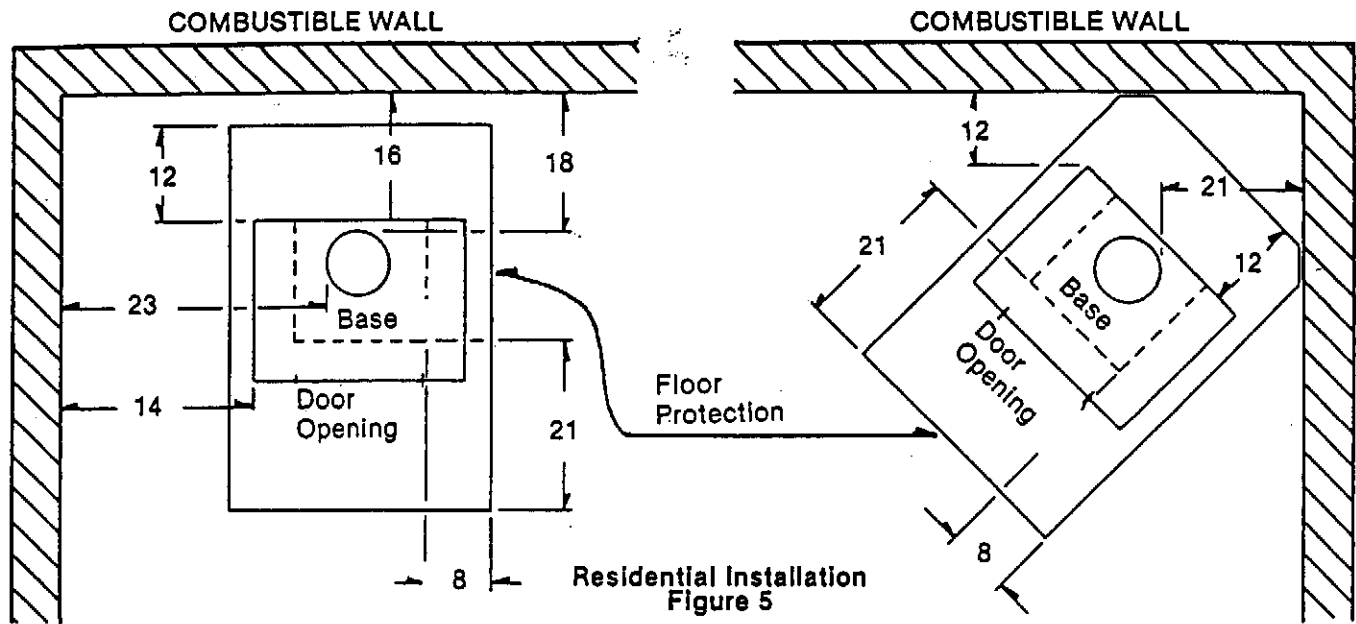

FLOOR PROTECTION

Floor Protection Material: 1/2" millboard or 2 layers of U. L. listed floor protector or a non-combustible material equal to 1/2" thick millboard having a thermal conductivity of $K = 0.84 \text{ BTU in/ft. hr}^\circ\text{F}$.

The floor protector must extend beyond the base:

- 8" from each side
- 21" from the front
- 12" from the back

These dimensions provide the required clearances from the door opening.

CHIMNEYS

There are two major types of stove pipes, insulated and not insulated. Insulated stove pipe and air cooled stove pipe are listed as CLASS A and are actually pre-fabricated chimney.

Freestanding wood stoves can only be vented into existing chimneys or into a listed, 8", low heat, pre-fabricated, metal chimney system (listed by Underwriters Laboratories, Inc. or other approved laboratory) installed through the ceiling. Horizontal installations are not allowed. Before installation of any wood burning unit to an existing chimney, take care that the chimney is sound. There should not be cracks or holes. Relining or rebuilding may be necessary to make the chimney safe and efficient and bring it into conformity with local codes. **UNDER NO CONDITIONS MAY MORE THAN ONE APPLIANCE BE CONNECTED TO A CHIMNEY.** A proper chimney is most important for safe, satisfactory operation of any wood heating system.

Generally, the taller the chimney, the stronger, more dependable the draft. The chimney should be kept warm to enhance the draft. This will also protect against creosote accumulation caused by condensation of water vapor and smoke. A build-up of creosote can reduce the draft and will become a potential fire hazard. See CREOSOTE.

A chimney should extend at least three feet above a flat roof, or at least two feet above any part of the roof within 10 feet. Chimney tops should NEVER be near trees or other tall objects that might cause down-drafts.

CHIMNEY CONNECTORS

CLASS A chimney is not normally required as a chimney connector for residential installations. Generally speaking, heavy duty, single wall, blue and black steel pipe (not less than 24 gauge is used to connect the stove to a masonry or CLASS A factory built, pre-fabricated chimney.

Insulated and not insulated pipe is available from numerous manufacturers. Consult local building codes and fire codes to determine which type of pipe may be safely installed. Ask your local dealer about the availability of types of pipe which meet local codes. See Fig. 7 for approved pipe systems.

The stove collar accepts only 8" pipe. The small end of the pipe fits into the collar to enable any distillates which may form in the chimney to fall back into the stove.

The chimney connector can also be used horizontally as a connection between the stove and masonry chimneys or CLASS A chimneys, provided that the length does not exceed three (3) feet AND THE PIPE SLOPES UPWARD TOWARD THE CHIMNEY AT A RATE OF 1/4" PER FOOT. This slope in the horizontal connection is required to facilitate the drainage of creosote deposits back into the stove.

The chimney connector is to be attached to the smoke collar with two screws.

OUTSIDE AIR SUPPLY

Residential Installations: It is not mandatory that outside air for combustion be used. However, if local codes require it, an Outside Air Kit is available from your dealer.

Mobile Home Installations: For proper installation, it is mandatory that outside air for combustion be used. The Outside Air Kit is included in the Mobile Home Kit.

Note: Install Rear Heat Shield BEFORE using this stove.

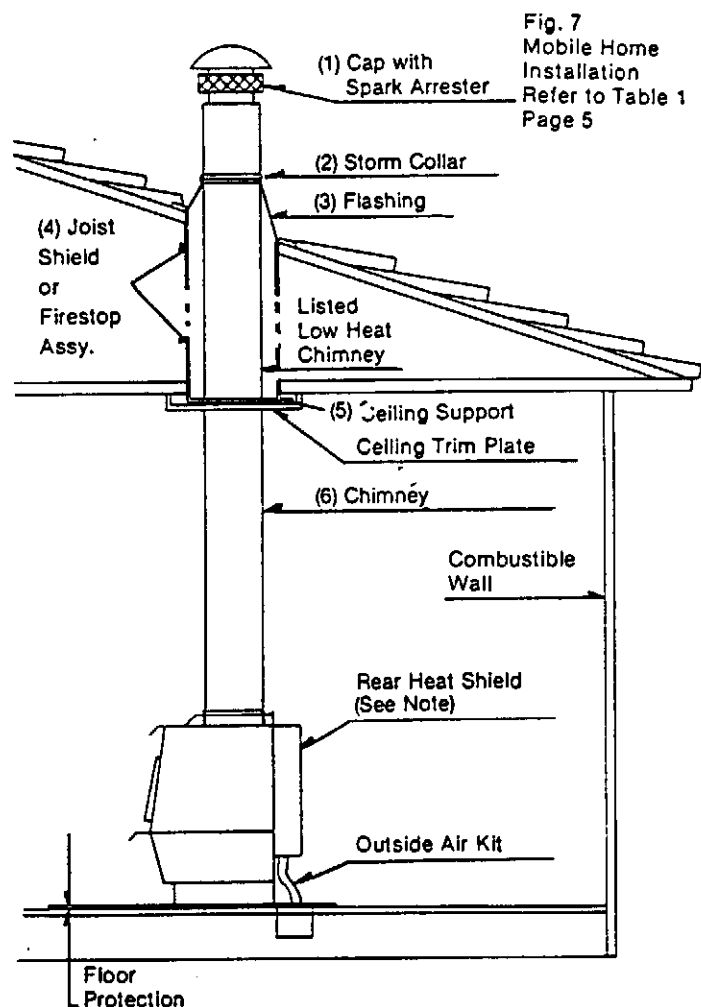

Mobile Home Installation

TABLE 1

	Ameri-Vent	White Metal	Security	Pro-Jet	Metalbestos	Hart and Cooley	Dura-Vent	Dura-Vent DVL
1	8FBRCA	8W-CA	8CPE	RCSA	8S-CT 8S-SA	8-DC	5278	5278
2	8FBSC	8W-SC		SC	8S-SC	8-DS	5279	5279
3	8FBRF	8W-RF	8FMH	RF-17	8S-AF	8 DF/8 DTF	5249	5249
4	8FBFA	8W-FSA	RRS CSB	RRS CSB	8S-JS	8DSS/8DPA		5248B
5		8W-TC	8RSMH 8RSAMH		8S-TC		5261	8889
6	8FB**	8W**	8L	GL** SL**	8S**	8-DP	52**	5221

** = length of pipe section (i.e. 12", 24" 36")

INSTALLATION

1. Set hearth and stove in location for marking holes in accordance with the dimensions listed in Figures 3 through 6 of these instructions.
2. Mark the position for the hole in the ceiling and roof by using a string and plumb-bob.
3. Check that the intended location will not interfere with floor joists, ceiling joists, or rafters before proceeding further.
4. (If required), mark the positions of the hole for the outside air pipe.
5. (If required), move the stove and, using a saber saw with a masonry blade, cut a 6" diameter hole for the outside air pipe.
6. Cut a pilot hole in the ceiling.
7. Cut a 14½" square hole and frame in both sides of this hole in both ceiling and roof. (FOR SAFE INSTALLATION, THIS HOLE MUST NOT BE SMALLER THAN 14½").
8. Measure the distance from the ceiling to the top of any combustible material. If required, trim the top of the joist shield so that it will clear any combustion material when installed in Step 12. Note that the joist shield may extend completely through the roof on some installations and may require trimming, only to allow the proper positioning and attachment of the roof flashing and storm collar. See Figure 4.
9. Slide the stove back into position.
10. Install the Combustor. Do not handle it any more than necessary for installation. The Combustor will have a stainless steel band holding an insulating material in place. This insulating material will expand when heated the first time, to seal the Combustor in place. Remove and retain the 5½" wide deflector-2 covering the combustor seat. Reach in through the flue opening and set the Combustor in place on the Combustor Seat which is mounted on top of the Dome. See Fig. 8. Install Deflector-2.
11. To start installing pipe, turn the first section of pipe upside down and slip the small end of the pipe inside the stove flue. Follow manufacturers installation instructions.
12. Install the remaining lengths of pipe one on top of the other to the finished height of the chimney connector, and secure to each other. When approaching the ceiling, slip the ceiling trim plate and joist shield over the chimney so that after the chimney is extended through the ceiling, the ceiling trim plate can be secured to the ceiling. The joist shield rests on the ceiling trim plate but is not secured to it. See Figure 4.
13. Slip the roof flashing down over the chimney and nail to the roof being careful to keep the pipe centered in the opening. NOTE: To meet the code, the chimney must extend above the roof at least three feet and two feet above any area of the roof within ten feet of the chimney.
14. (If required), attach the Outside Air Cap and Hose.
15. Install the side ceramics by holding each carefully in place within the raised outline. Gently fold the tabs on the stove face around the ceramic tiles. REMEMBER, these ceramics are a clay product and must be handled carefully. THEY ARE FRAGILE.
16. On Jet-Air models, attach the blower motor. This motor is attached to the blower intake on the rear of the stove with four self-tapping screws. It is equipped with a three prong (grounded) plug to prevent shock hazard. THIS PLUG SHOULD BE INSERTED DIRECTLY INTO A PROPERLY GROUNDED, THREE PRONGED RECEPTACLE. DO NOT CUT OR REMOVE THE GROUNDING PRONG FROM THIS PLUG.

NOTE: To provide a proper ground between the stove and the motor case, install the ¼" internal tooth lock washer under one of the blower mounting screws.

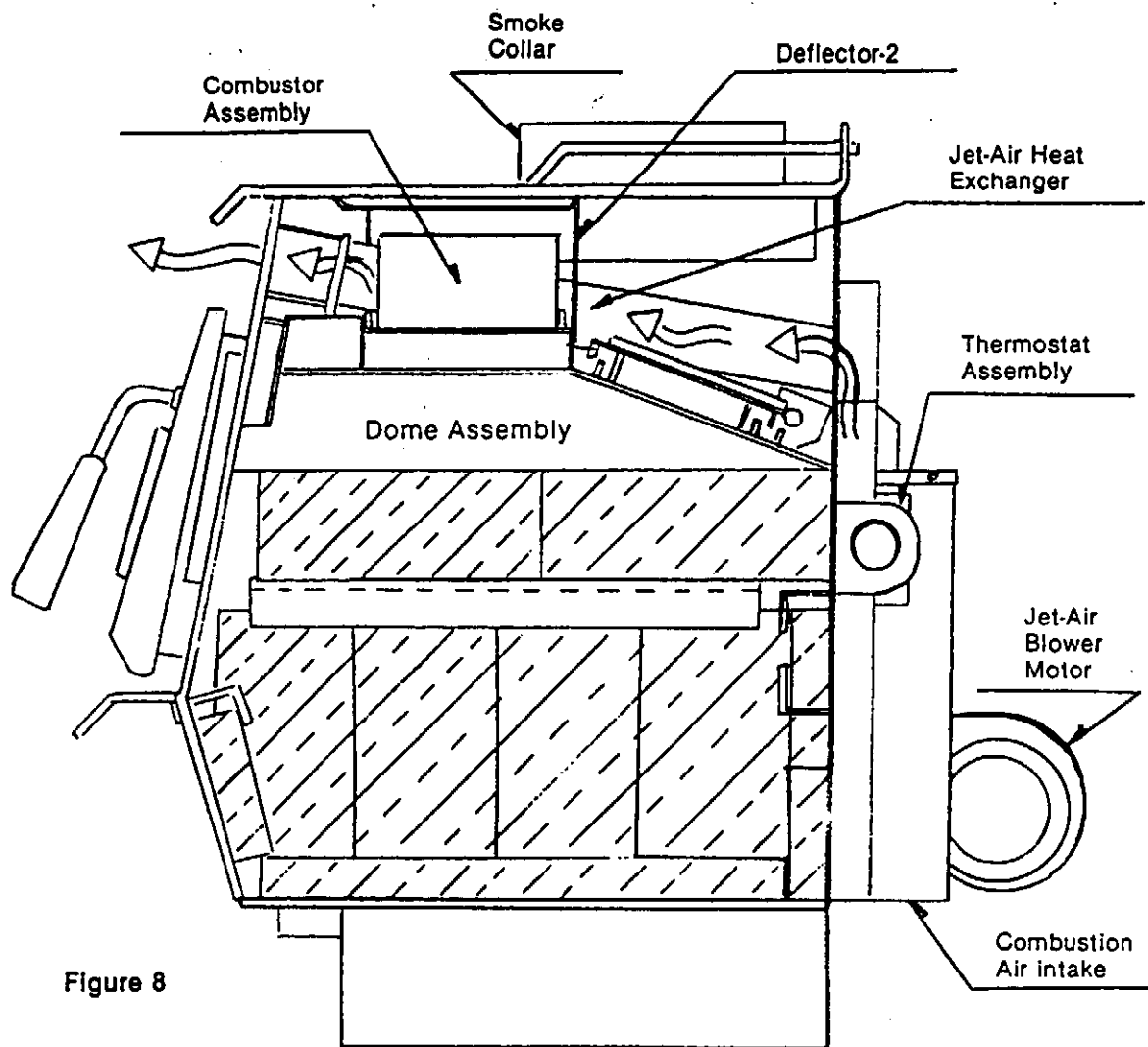

Figure 8

FUEL

THIS STOVE IS FOR USE WITH WOOD ONLY

Green softwoods burn slowly and with smoke. The soot and moist tar from this smoke sticks to the inside of the chimney. Moisture in green wood will release a great amount of vapor which will condense on the inside of the chimney. The use of dry wood will retard any excessive build up.

Do not burn trash, paper, pine branches or artificial fire logs. Such abuse may void the warranty.

FLAMMABLE LIQUIDS

NEVER use gasoline, gasoline-type lantern fuel, kerosene, charcoal lighter fluid, or similar liquids to start or "freshen up" a fire in this stove. Keep all such liquids well away from the stove while it is in use.

THE FIRST FIRE

1. DO NOT USE GRATE. BUILD FIRE DIRECTLY ON THE HEARTH.
2. Set the thermostat to HIGH and open the By-Pass door.
3. Place two or three large balls of crumpled paper on the hearth. Lay some small dry sticks or wood chips on top of the paper to use as kindling. Use enough to establish a good fire base. Lay some larger pieces of wood on top of the kindling. Lay the wood in a 'front-to-back' position rather than the usual side-to-side position. Light the paper and close the door tightly. Allow the fire to get a good start. Close the By-Pass door.

4. When nearly all the wood in the firebox is burning, open the By-Pass door, then open the loading door and load the firebox with wood, maintaining the front-to-back loading position. Close the loading door. Close the By-Pass door.
5. Adjust the thermostat control knob for the heat setting desired. The control knob is factory adjusted so that the thermostat setting corresponds to the back temperature adjacent to the thermostat sensor. The thermostat was designed to allow the stove to come up to temperature quickly. This small surge of heat in the beginning of the burn cycle provides the extra heat needed to bring your room up to temperature. It also creates clean burning conditions in the early part of the woodburning cycle when the tendency to produce creosote is the greatest.
6. CAUTION: Your stove is controlled thermostatically and large increases in settings could cause creosote, which might be present in your flue pipe, to ignite without your knowing it.
7. HELPFUL HINTS: Your thermostat will provide very even heat in your home. Our home tests have indicated that only electric heat is more even. Most homes are sufficiently massive that the steady heat coming from your thermostat-controlled stove will provide steady room temperature for hours even though outside temperatures are changing. For this reason we recommend that you change the thermostat setting infrequently, generally no more than 3 times daily.
8. On the Jet-Air model, turn on the fan if desired.
9. Probably the least understood requirement in maintaining a good fire is that of establishing a good base of coals. Many new stove users hesitate to load enough wood to sustain a fire. A good bed of hot coals will maintain a more even temperature as well as getting the new load of wood started easily.

SUBSEQUENT OPERATION

When you add fuel to the stove, open the By-Pass door first; then open the door slightly (about 1") and hold in that position for 10-30 seconds or until the fire livens up. Then open the door the rest of the way.

Four or Five 5" or 6" diameter logs may burn for up to 14 hours. This will vary considerably with the variables of model of stove, type of wood, whether the wood is "seasoned," the thermostat setting, the position of the stove in the house, and how well the house is insulated. The stove can be fully loaded without increasing the heat output. The stove will simply burn longer.

CAUTION: After the fire has been allowed to liven up and the door closed, DO NOT open the door for at least 4 - 5 minutes. Hot gasses build up right after the door is closed and the addition of oxygen when the door opens will cause a rapid combustion, sending smoke into the room.

CAUTION: Always open the BY-PASS Door BEFORE opening the door to feed the fire. Keep the BY-PASS Door closed at all other times.

Under normal operations, the thermostat should be set on a low setting, and at this setting the stove is capable of heating an average size home. The setting may be increased as required to achieve the desired room temperature. The thermostat is set at the factory and should not be tampered with. If the thermostat breaks, the damper will close automatically.

DOOR GASKETS

Check the loading door gasket for deterioration at least twice each heating season. The By-Pass door gasket should be checked for deterioration before the start of each heating season.

REPLACING THE COMBUSTOR ASSEMBLY

The Blaze King Catalytic Thermometer on the top of the stove should read between 600° and 1800°F when the combustor is in operation. If the temperature does NOT exceed 1000°F, with a hot fire, contact your dealer. If the combustor must be replaced. Follow this procedure:

1. The stove must be allowed to burn out and cool down.
2. Remove the chimney or chimney connector from the smoke collar on the top of the stove.
3. Remove and retain the 5½" wide deflector-2 covering the combustor assembly.
4. a. If the stove has been burned:
 1. Reach in through the smoke collar and remove the combustor assembly. The insulating material will have expanded (as compared to the new assembly) but it should come out without leaving any residue.

2. Inspect the combustor seat to determine if any residue is present. Wipe clean with a dry cloth. **DO NOT USE DETERGENTS, STEEL OR METALLIC BRUSHES, OR SOLVENTS.**

b. If the stove has not been burned:

Install the Combustor. Do not handle it any more than necessary for installation. The Combustor will have a stainless steel band holding an insulating material in place. This insulating material will expand when heated the first time, to seal the combustor in place. Reach in through the smoke collar and set the Combustor in place on the Combustor seat which is mounted on top of the Dome.

5. Install the Deflector-2 removed in Step 3 above.

6. Install the chimney (chimney connector)

NOTE: Any time the combustor is removed, the insulating material forming the seal between the Combustor and the Combustor Seat **MUST** be replaced.

ASH REMOVAL

Ashes should be removed any time they start to cover the draft inlet into the firebox. The frequency with which you need to empty the ashes depends on the type of fuel being used. Remove ashes only when they are cold so the hot coals are not dumped where they may start a fire.

DISPOSAL OF ASHES

Ashes should be placed in a metal container with a tight-fitting lid. The closed container of ashes should be placed on a non-combustible floor or on the ground, well away from all combustible materials, pending final disposal. If the ashes are disposed of by burial in soil or otherwise locally dispersed, they should be retained in the closed container until all cinders have thoroughly cooled.

CREOSOTE—FORMATION AND NEED FOR REMOVAL

When wood is burned slowly, it produces tar and other organic vapors, which combine with expelled moisture to form creosote. The creosote vapors condense in the relatively cool chimney flue of a slow-burning fire. As a result, creosote residue accumulates on the flue lining. When ignited, this creosote makes an extremely hot fire.

The chimney connector and chimney should be inspected at least once every two months during the heating season to determine if a creosote build-up has occurred.

If creosote has accumulated, it should be removed to reduce the risk of a chimney fire.

LUBRICATION

Lubricate the fan motor bearings of Jet-Air models every 6 months with 10 to 20 drops of SAE 10W or 20W non-detergent oil (ML type) or with electric motor oil.

CAUTION: DO NOT over-lubricate. The excess oil may damage the windings or electrical wiring on the motor.

PAINT

If the black finish on the stove ever becomes blemished, you can repaint with high temperature paint available from your dealer. **DO NOT** paint the stove while it is **HOT**.

FURTHER INFORMATION

For further information on using your heater, obtain a copy of the National Fire Protection Association publication, "Using Coal and Woodstoves Safely" NFPA #HS-10. The address is:

National Fire Protection Association
Batterymarch Park
Quincy, MA 02269

AUTHORIZED SERVICE REPRESENTATIVE

Your local Blaze King dealer is your authorized service representative. Should you have any problems with operations or maintenance of your Blaze King stove, contact him as soon as possible. He will assist you in resolving any operation problems, provide replacement parts, and/or arrange warranty repairs as required. He will need information such as model, serial number, date of purchase, and a summary of the problem. A list of some of the more common replacement parts is given below.

REPLACEMENT PARTS

Item	Part #	Description
Ceramics		
Blaze Princess	0116	orange, brown, blue, green, black
Door Handles	0118	
Motor	0112	
Spray Paint	0128	Aerosol Can
Thermostat Knob	0102	
Outside Air Kit	0150	
Door Gasket	0180	
By-Pass Door Gasket	0182	
Combustor	0330	
Combustor Seat Gasket	0341	Replacement Gasket
Blaze King Catalytic Thermometer	0342	

OWNER'S INSTALLATION AND OPERATION INSTRUCTION BOOK

Blaze[®] King

WOOD STOVES

BLAZE KING, Princess catalyst model, Top Vent
PE-1000 and PEJ-1000

MANUFACTURED UNDER LICENSEE AGREEMENT

FROM: WOODCUTTERS MFG., INC.
Route 4, Box 218
Walla Walla, WA 99362

BY:

OM-9

11/09/82
RCR